

FR/ Annexe	ES/ Apéndice	PT/ Anexo	IT/ Appendice
EL/ Παράρτημα	PL/ Załącznik	RU/ Приложение	UK/ Додаток
RO/ Anexa	EN/ Appendix		

Ean code	**Model No.	size(mm)	profile
3276006000482	RE-FI70-S-C	700x1950	bright chrome
3276000231462	RE-FI70-M-C	700x1950	mat black
3276000231509	RE-FI70-B-S	700x1950	brushed silver nickle
3276000231455	RE-FI70-S-F	700x1950	bright chrome
3276006000529	RE-FI80-S-C	800x1950	bright chrome
3276006000604	RE-FI80-M-C	800x1950	mat black
3276006000567	RE-FI80-B-S	800x1950	brushed silver nickle
3276000231479	RE-FI80-S-F	800x1950	bright chrome
3276006000642	RE-FI90-S-C	900x1950	bright chrome
3276006000727	RE-FI90-M-C	900x1950	mat black
3276006000680	RE-FI90-B-S	900x1950	brushed silver nickle
3276000231486	RE-FI90-S-F	900x1950	bright chrome
3276006000765	RE-FI100-S-C	1000x1950	bright chrome
3276006000840	RE-FI100-M-C	1000x1950	mat black
3276006000802	RE-FI100-B-S	1000x1950	brushed silver nickle

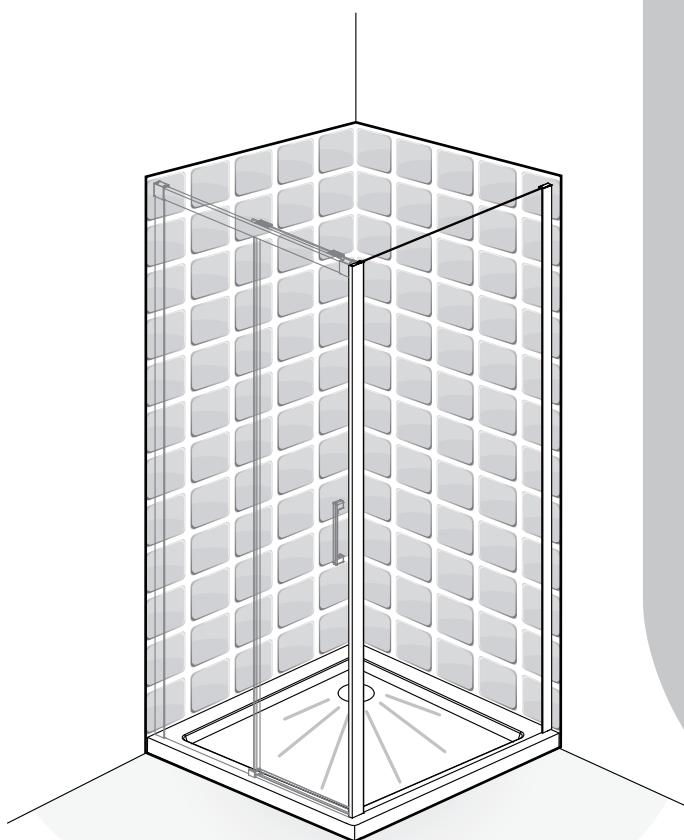

REMIX



- FR** Notice de Montage, Utilisation, Entretien
- ES** Instrucciones de Montaje, Utilización y Mantenimiento
- PT** Instruções de Montagem, Utilização e Manutenção
- IT** Istruzioni per il Montaggio, l'Uso e la Manutenzione
- EL** Εγχειρίδιο συναρμολόγησης, χρήσης και συντήρησης
- PL** Instrukcja Montażu, Użytkowania i Konserwacji
- RU** Руководство По Сборке и Эксплуатации
- UK** Керівництво По Збірці і Експлуатації
- RO** Manual asamblare, utilizare și întreținere
- EN** Assembly - Use - Maintenance Manual

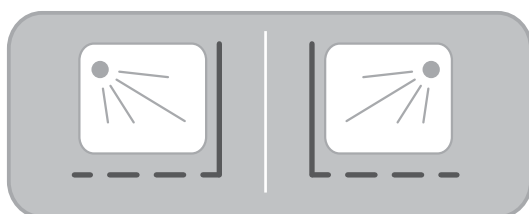

Traduction de la version originale du mode d'emploi / Traducción de las Instrucciones originales / Tradução das Instruções Originais / Traduzione delle istruzioni originali / Μετάφραση των πρωτότυπων οδηγιών / tłumaczenie instrukcji oryginalnej / Перевод оригинала инструкции / Переклад оригінальної інструкції / Traducerea instructiunilor originale / Original Instructions



2016/08

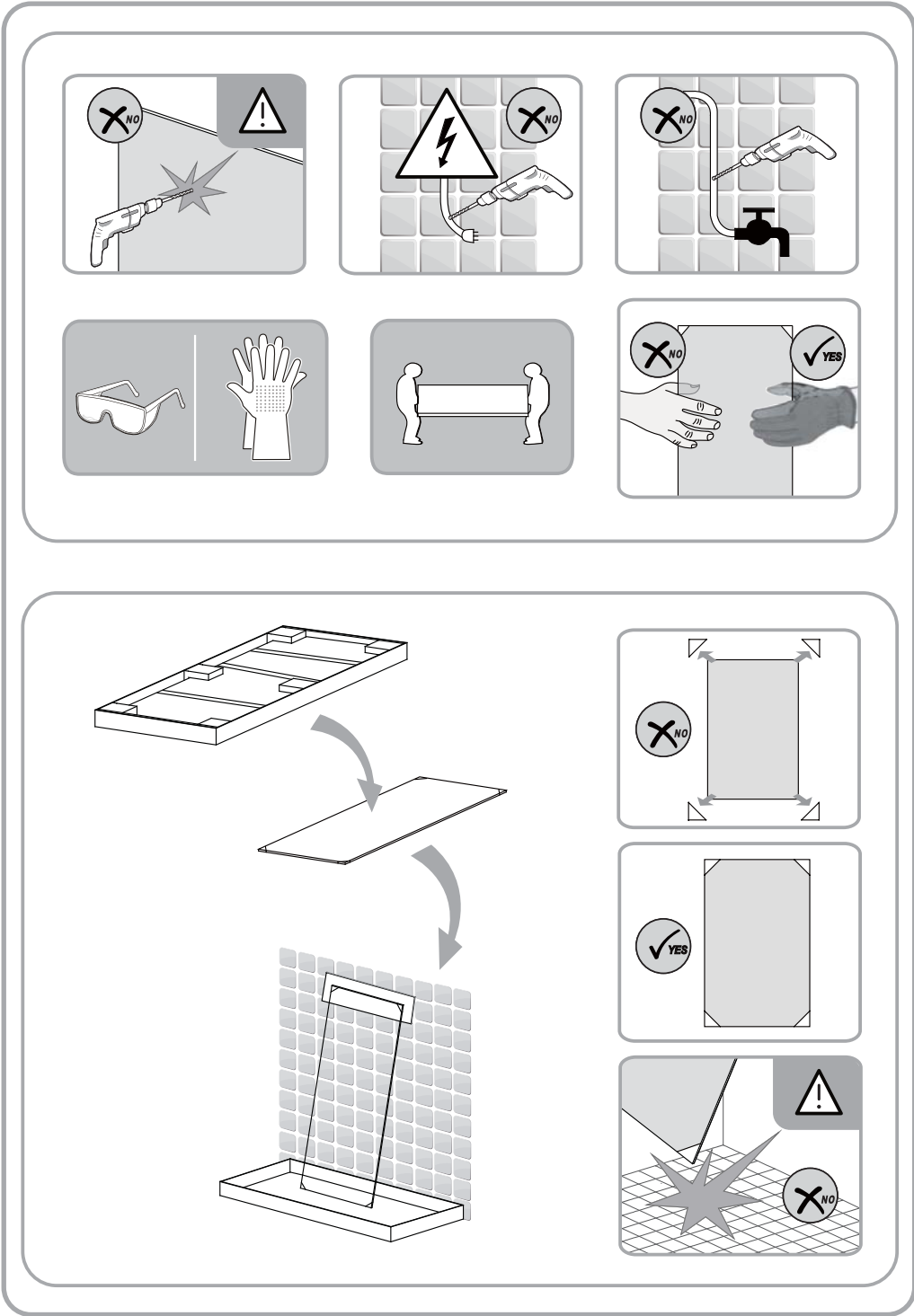

FR Vérifiez que les chevilles murales fournies sont appropriées à votre mur (celles fournies dans l'emballage sont conçues pour le béton). Sinon, utilisez des vis et des chevilles murales adaptées au type de matériau de votre mur. Pour obtenir des conseils concernant les vis et les chevilles appropriées à votre mur, demandez à un vendeur spécialisé.

ES Compruebe que todos los tacos suministrados puedan ser utilizados con su pared (los incluidos en la caja son para hormigón). En caso contrario, utilice tornillos y tacos de pared apropiados para el material de su pared. Para información acerca de las fijaciones y tornillos apropiados para su pared, consulte con un asistente de ventas especializado.

PT Certifique-se de que as buchas fornecidas são adequadas à sua parede (as fornecidas na embalagem são para betão). Caso contrário, use parafusos e buchas adequados ao tipo de material da sua parede. Para se aconselhar acerca dos parafusos e buchas adequados à sua parede, fale com um assistente de vendas especializado.

IT Verificare che i tasselli da parete forniti siano compatibili con la propria parete (quelli forniti con l'articolo sono per cemento). Altrimenti, utilizzare viti e tasselli adatti per la superficie della propria parete. Per ottenere consigli e suggerimenti sulle viti e i tasselli più adatti alla propria parete, consultare un rivenditore specializzato.

EL Βεβαιωθείτε ότι οι παρεχόμενες στερεώσεις τοίχου είναι κατάλληλες για τον τοίχο σας (οι παρεχόμενες στη συσκευή προορίζονται για μπετό). Αλλιώς χρησιμοποιήστε βίδες και στερεώσεις τοίχου κατάλληλες για τον τύπο υλικού του τοίχου σας. Για να λάβετε συμβουλές σχετικές με τις κατάλληλες βίδες και τα εξαρτήματα για τον τοίχο σας, ρωτήστε έναν ειδικό πωλητή.

PL Prosimy sprawdzić, czy dostarczone kolki do ścian nadają się do użycia w posiadanej ścianie (kolki dostarczone w zestawie są przeznaczone do betonu). Jeśli tak nie jest, należy użyć śrub i kolków odpowiednich do materiału, z którego wykonana jest ściana. Aby uzyskać poradę w sprawie śrub i elementów montażowych odpowiednich do danego typu ściany, należy zwrócić się z pytaniem do wyspecjalizowanego sprzedawcy.

RU Убедитесь, что прилагаемые дюбеля подходят для ваших стен (входящие в комплект дюбеля предназначены для бетона). В противном случае используйте шурупы и дюбеля, соответствующие материалу стены. Для получения рекомендаций по выбору шурупов и крепежных деталей, подходящих для вашей стены, обратитесь к специалисту-консультанту.

UK Перевірте, що анкери підходять для вашої стіни (ті, що постачаються в упаковці – для бетону). В іншому випадку використовуйте гвинти й стінові анкери, що відповідають матеріалу вашої стіни. Для отримання консультацій щодо гвинтів й фітінгів для вашої стіни зверніться до відповідного продавця-консультанта.

RO Verificați ca toate ancorele de perete furnizate să fie adecvate pentru peretele dumneavoastră (cele furnizate în pachet sunt pentru beton). În caz contrar, folosiți șuruburi și ancore de perete adecvate pentru tipul de material din care este peretele dumneavoastră. Pentru a obține recomandări privind șuruburile și armăturile adecvate pentru peretele dumneavoastră, întrebați un vânzător specializat.

EN Check that wall anchors provided are suitable for your wall (those provided in the package are for concrete). Otherwise, use screws and wall anchors suited to the type of material of your wall. To obtain advice on the screws and fittings suited to your wall, ask a specialized sales assistant.

2



3M

Assemble with this side, with easy clean treatment, on the inside.

İze karşı işleme tabi tutulmuş bu yüz iç tarafa doğru konulmalıdır.

Cette face, avec un traitement facilement nettoyable, doit être positionnée vers l'intérieur.

Esta cara está tratada para facilitar su limpieza y se debe colocar hacia el interior.

Esta face com tratamento para facilitar a limpeza, deve ficar voltada para o interior.

Questo lato, deve essere posizionato con il trattamento easy clean all'interno.

Эта сторона, обработанная средством против образования накипи, должна быть обращена вовнутрь.

Страна, оброблена засобом проти накипу, повинна бути звернена всередину.

Această față, tratată pentru curățare ușoară, trebuie poziționată spre interior.

Strona z powłoką zapewniającą łatwe czyszczenie powinna być skierowana do wewnątrz.

Αυτή η όψη, με επεξεργασία για εύκολο καθαρισμό, πρέπει να τοποθετηθεί προς το εσωτερικό.

V.7.2014



Attention danger / Atención: Peligro / Atencão perigo / Attenzione pericolo / Προσοχή κίνδυνος /
Uwaga niebezpieczeństwo / Внимание! Опасно! / Увага! Небезпечно! / Atenție, pericol / Caution danger



Correct / Correcto / Corretto / Corretto / Σωστό / Dobrze / Правильный /
Правильно / Corect / Correct



Incorrect / Incorrecto / Incorrecto / Errato / Λάθος / źle / Неправильный /
Неправильно / Incorect / Incorrect

Notes / Observaciones / Notas / Note / Σημειώσεις / Notatki / Примечания / Примітки / Note / Notes

FR Préparation

ES Preparación

PT Preparação

IT Preparazione

EL Προετοιμασία

PL Przygotowanie

RU Подготовка

UK Підготовка

RO Pregătire

EN Preparation

A

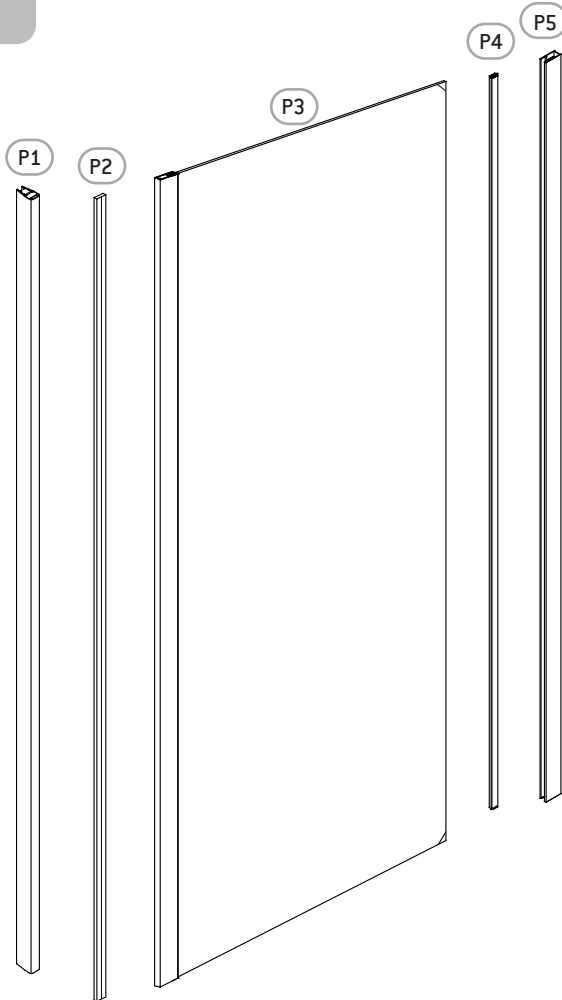
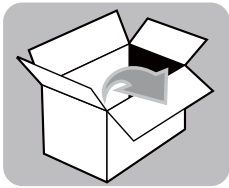

A

FR Préparation

ES Preparación

PT Preparação

IT Preparazione

EL Προετοιμασία

PL Przygotowanie









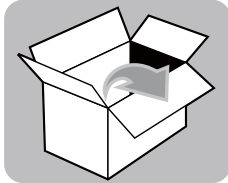

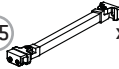
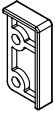

RU Подготовка

UK Підготування

RO Pregătire

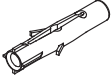
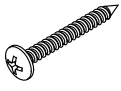
EN Preparation



H1  x2	H5  x2 ST 4x30mm	H16  x1	H17  x1	H55  x1
H56  x1	H57  x3	H58  x2 M 4x20mm	H59  x1	H68  x3 ST 4x12mm
H1  x3	H2  x3 ST 4x40mm	H39  x1	H47  x1 2.5mm	
H24  x1 3mm				

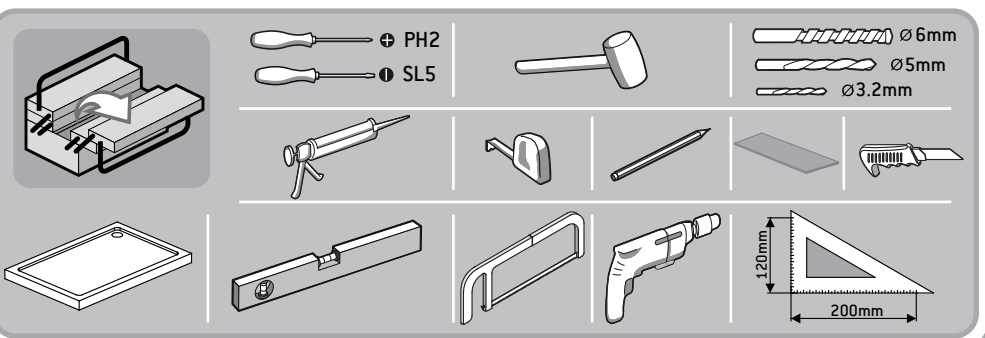

FR Montage

ES Montaje

PT Montagem

IT Montaggio

EL Συναρμολόγηση

PL Montaż

RU Сборка

UK Збірка

RO Montaj

EN Assembly

B

1

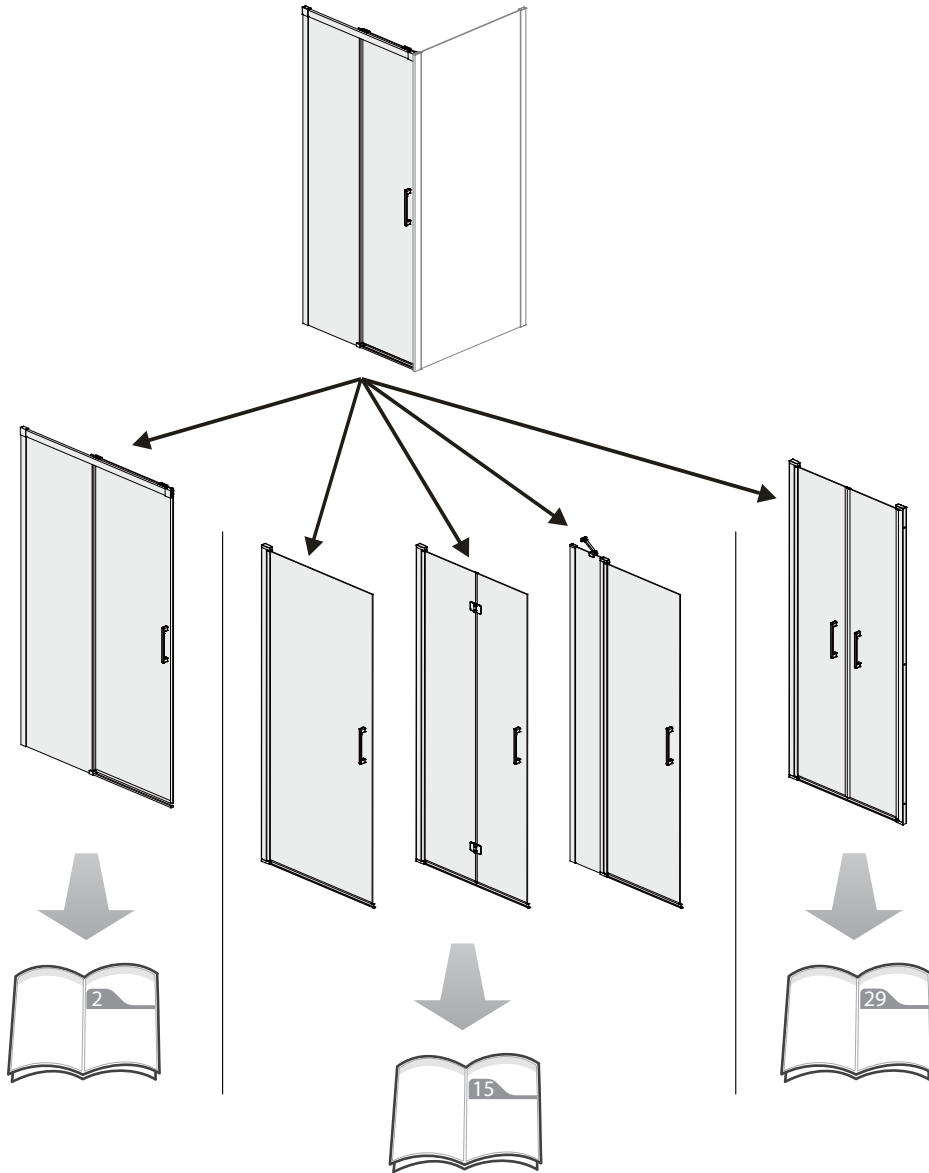

B

FR Montage

ES Montaje

PT Montagem

IT Montaggio

EL Συναρμολόγηση

PL Montaż

RU Сборка





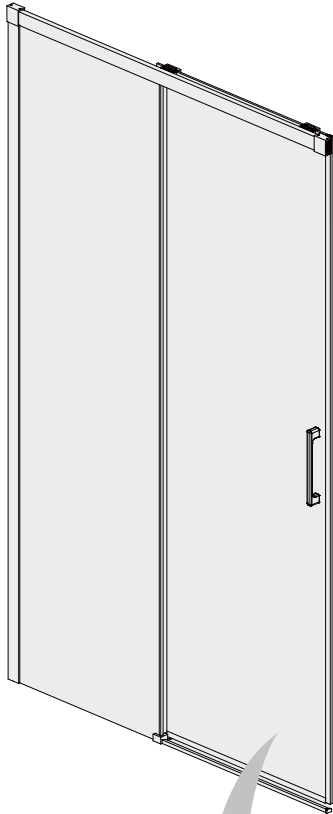

UK Збірка

RO Montaj





EN Assembly

2

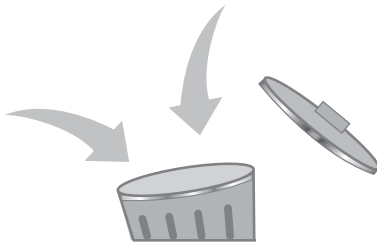

H1	 x2	H5	 x2 ST 4x30mm
H16	 x1	H17	 x1
H55	 x1	H68	 x3 ST 4x12mm



H1	 x3	H2	 x3 ST 4x40mm
H39	 x1	H47	 x1 2.5mm

FR Montage

ES Montaje

PT Montagem

IT Montaggio

EL Συναρμολόγηση

PL Montaż

RU Сборка

UK Збірка

RO Montaj

EN Assembly

B

3

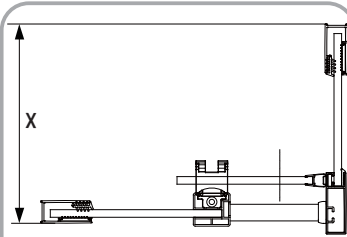

REMIX	X(mm)
700 x 1950mm	667 - 682
800 x 1950mm	767 - 782
900 x 1950mm	867 - 882
1000 x 1950mm	967 - 982

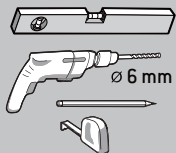
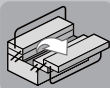
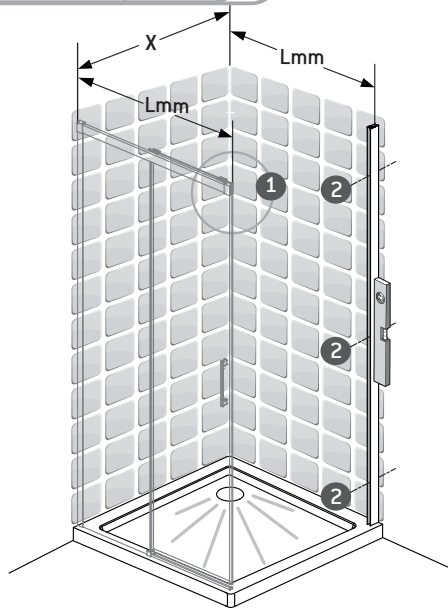
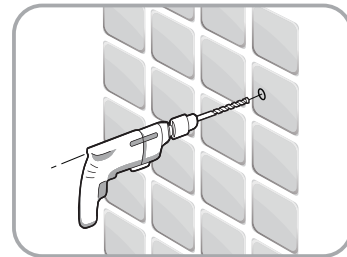
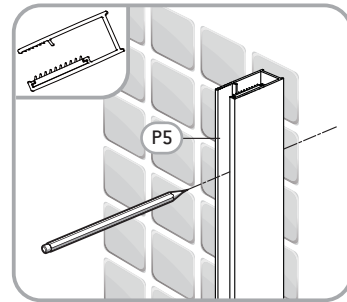
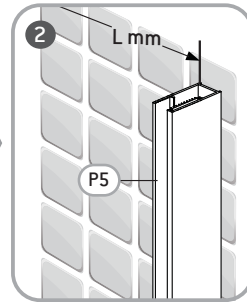
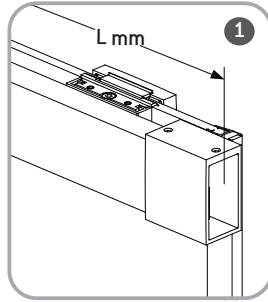

P5

x1



B

FR Montage

ES Montaje

PT Montagem

IT Montaggio

EL Συναρμολόγηση

PL Montaż

RU Сборка

UK Збірка

RO Montaj

EN Assembly

4

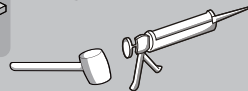
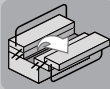
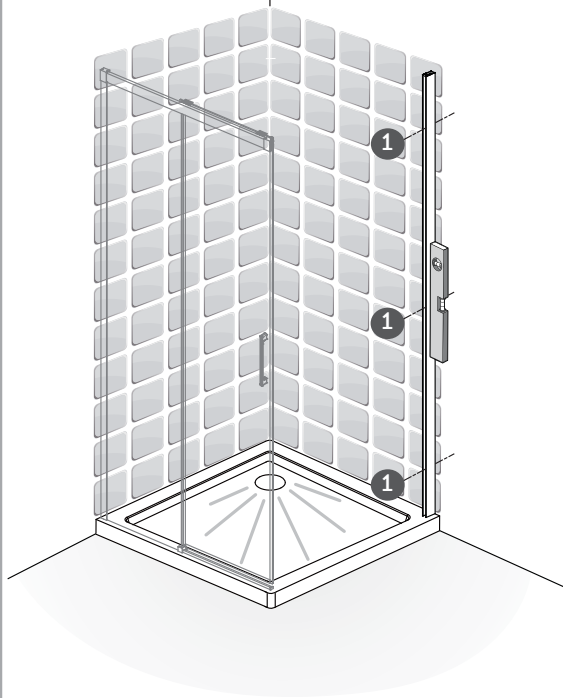
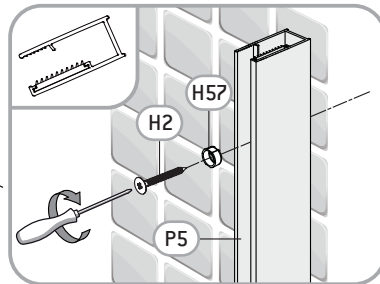
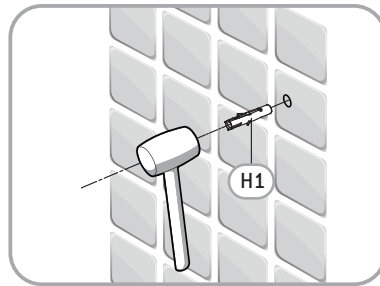
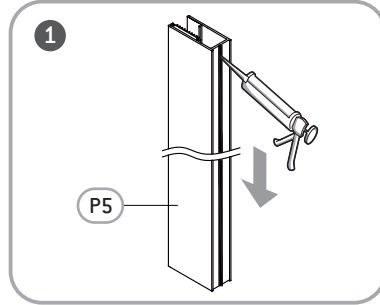
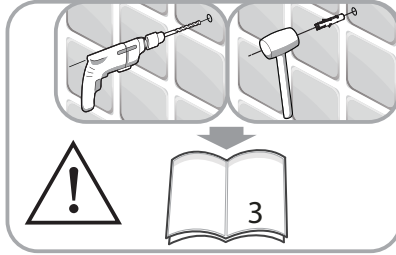

ST 4x40mm



FR Montage

ES Montaje

PT Montagem

IT Montaggio

EL Συναρμολόγηση

PL Montaż

RU Сборка

UK Збірка

RO Montaj

EN Assembly

B

5

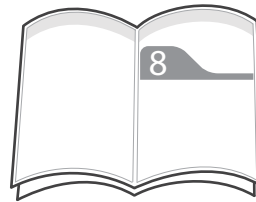
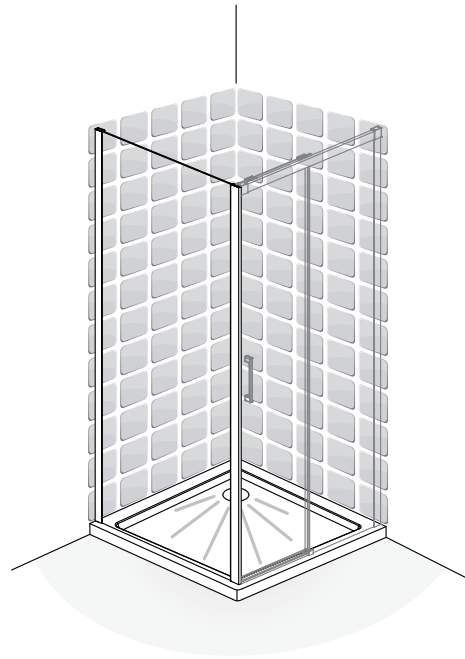
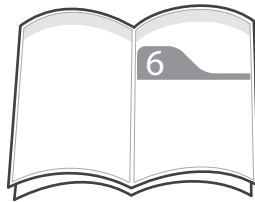
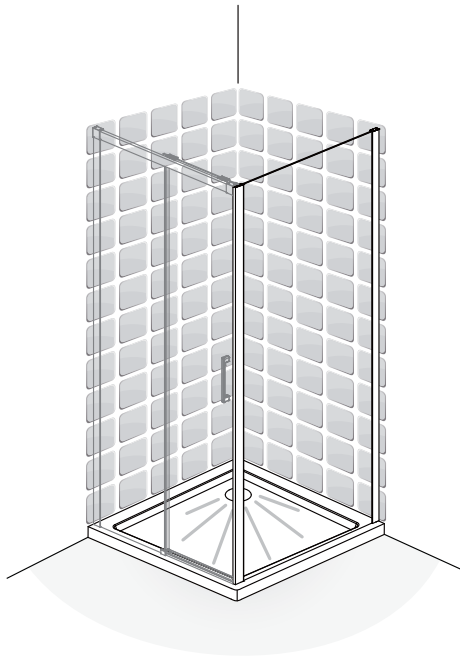

B

FR Montage

ES Montaje

PT Montagem

IT Montaggio

EL Συναρμολόγηση

PL Montaż

RU Сборка

UK Збірка

RO Montaj

EN Assembly

6

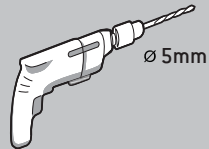
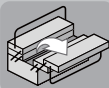
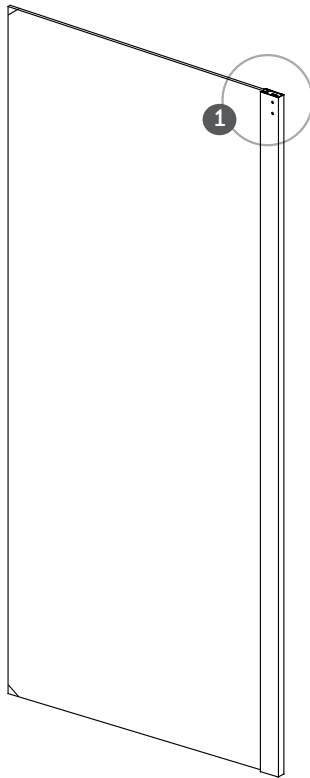
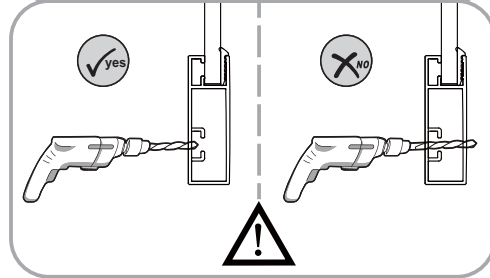
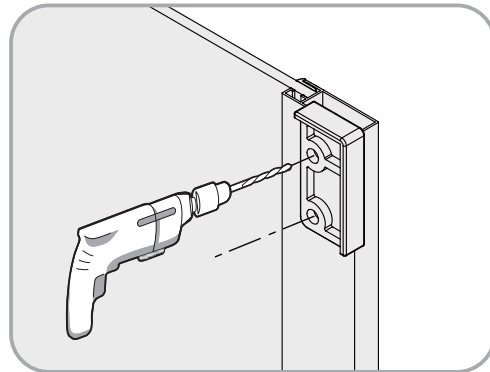
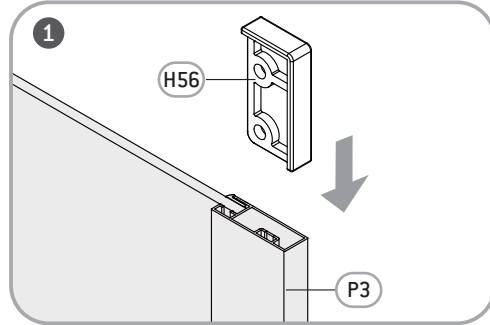
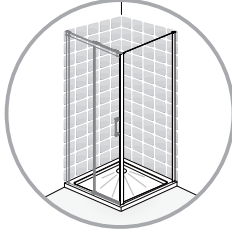

ø 5mm

P3

H56



x1



x1



FR Montage

ES Montaje

PT Montagem

IT Montaggio

EL Συναρμολόγηση

PL Montaż

RU Сборка

UK Збірка

RO Montaj

EN Assembly

B

7

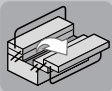
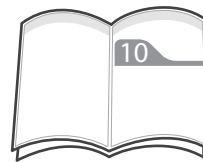
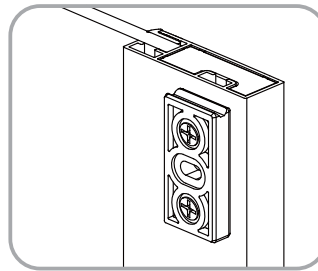
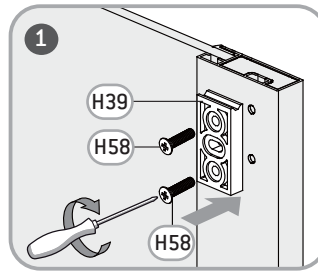
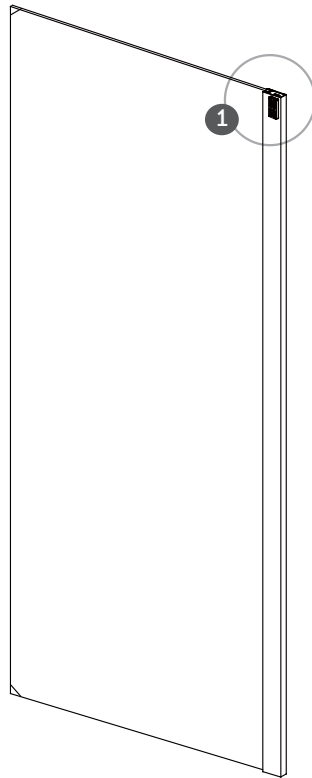
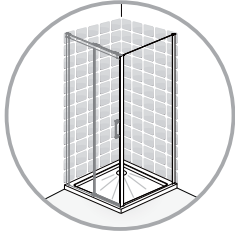

PH2

P3



x1

H58



x2

M 4x20mm

H39



x1



B

FR Montage

ES Montaje

PT Montagem

IT Montaggio

EL Συναρμολόγηση

PL Montaż

RU Сборка

UK Збірка

RO Montaj

EN Assembly

8

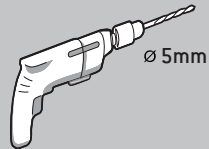
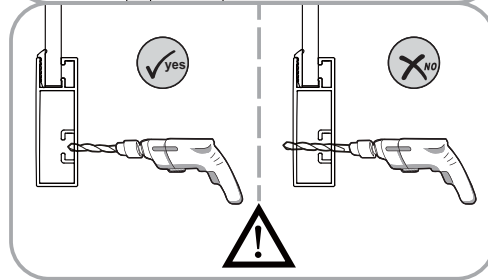
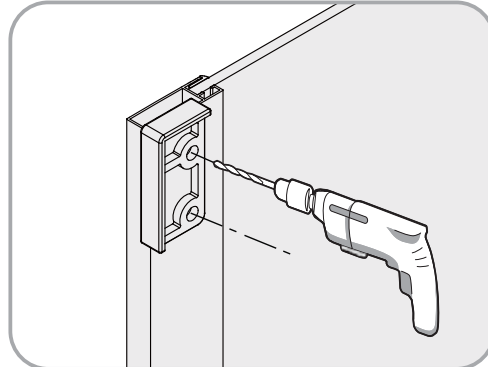
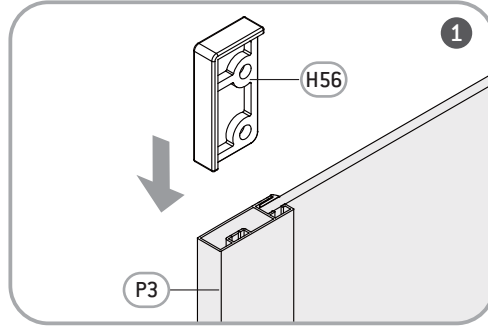
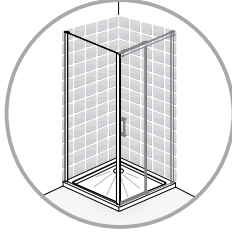

Ø 5mm

P3



x1

H56



x1



FR Montage

ES Montaje

PT Montagem

IT Montaggio

EL Συναρμολόγηση

PL Montaż

RU Сборка

UK Збірка

RO Montaj

EN Assembly

B

9

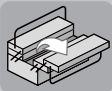
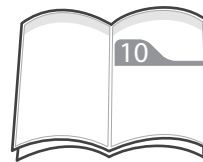
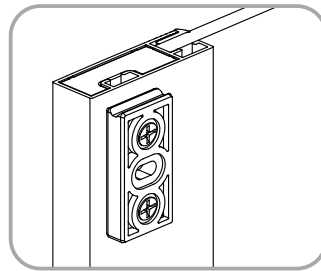
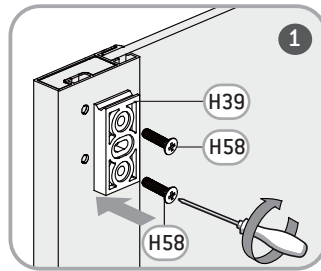
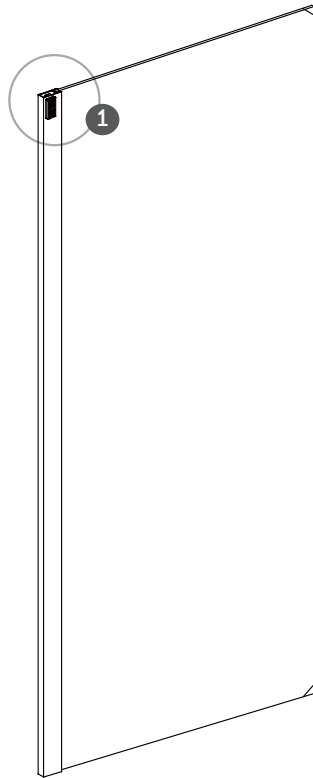
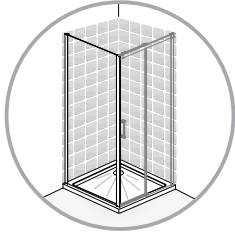

PH2

P3



x1

H58



x2

M 4x20mm

H39



x1



B

FR Montage

ES Montaje

PT Montagem

IT Montaggio

EL Συναρμολόγηση

PL Montaż

RU Сборка

UK Збірка

RO Montaj

EN Assembly

10

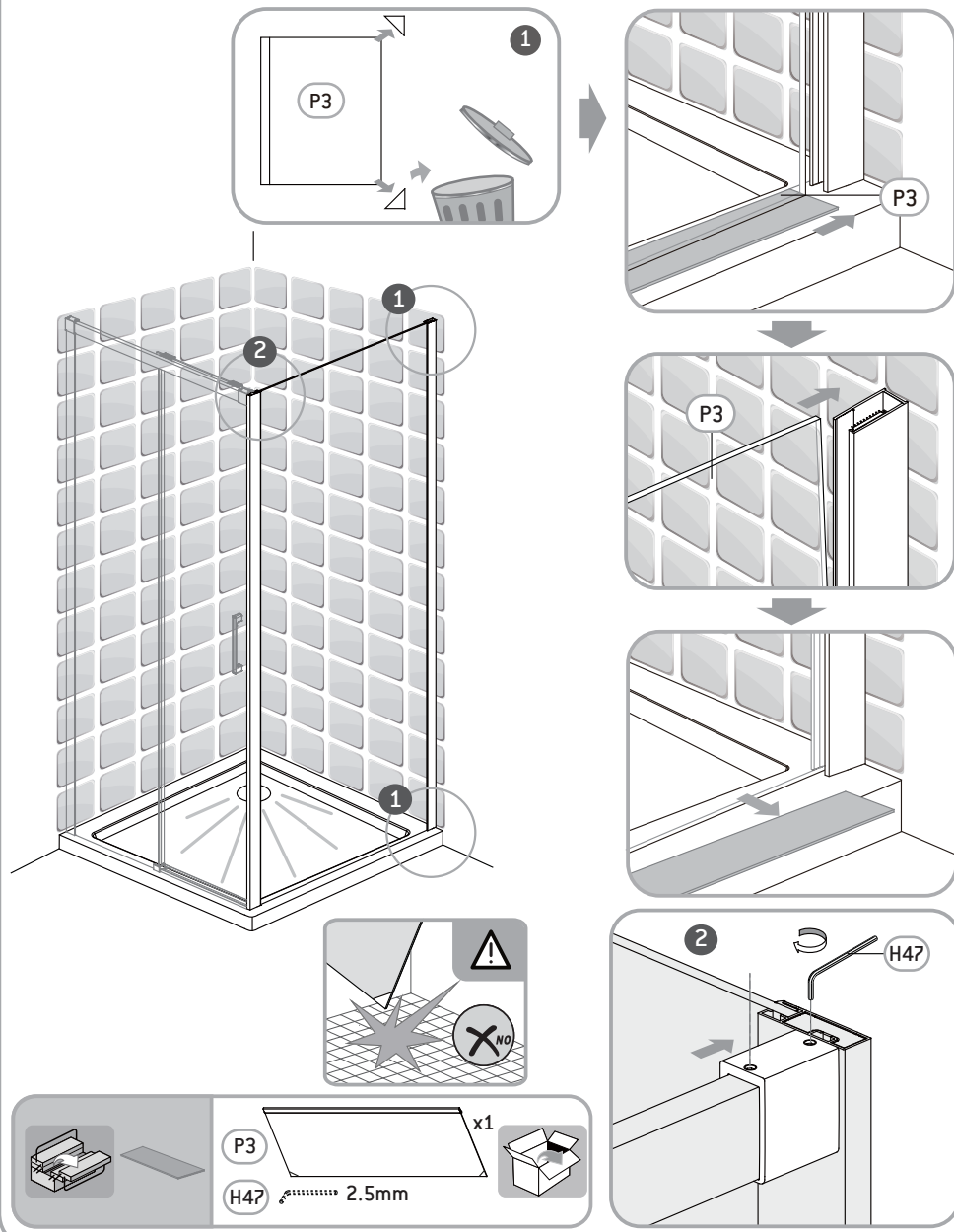

FR Montage

ES Montaje

PT Montagem

IT Montaggio

EL Συναρμολόγηση

PL Montaż

RU Сборка

UK Збірка

RO Montaj

EN Assembly

B

11

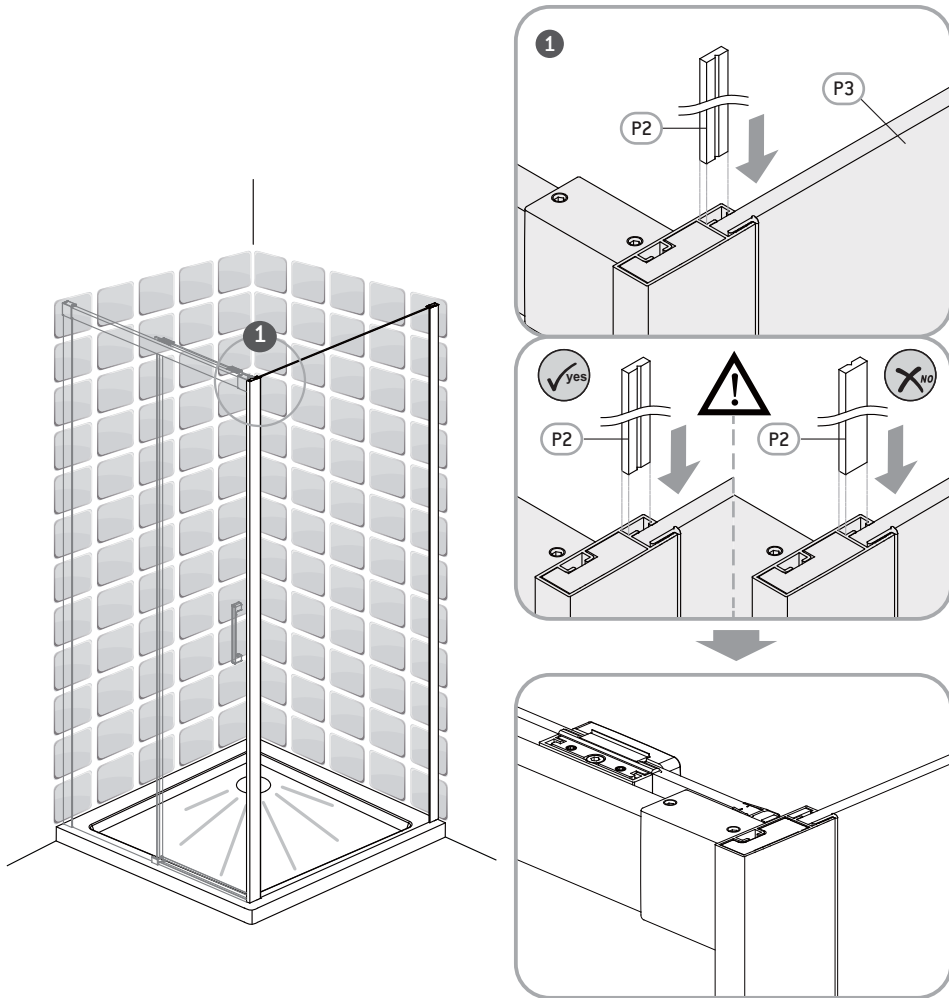

P2



x1



B

FR Montage

ES Montaje

PT Montagem

IT Montaggio

EL Συναρμολόγηση

PL Montaż

RU Сборка

UK Збірка

RO Montaj

EN Assembly

12

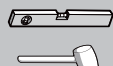
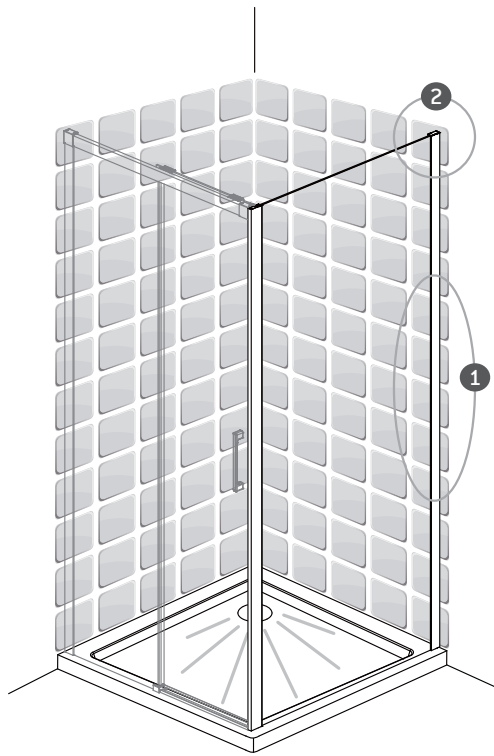
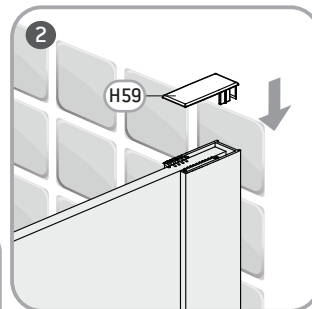
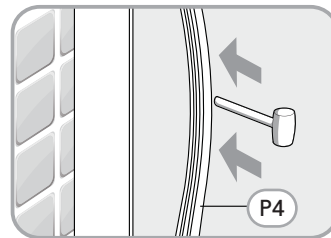
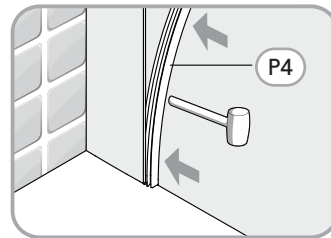
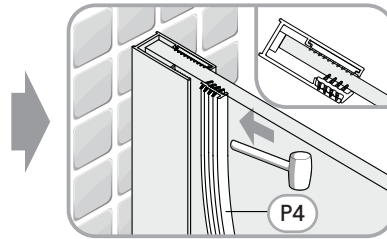
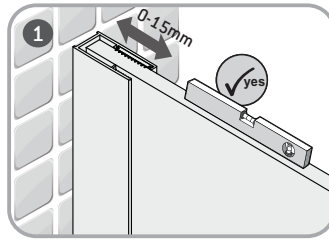

H59

x1

P4



x1



FR Montage

ES Montaje

PT Montagem

IT Montaggio

EL Συναρμολόγηση

PL Montaż

RU Сборка

UK Збірка

RO Montaj

EN Assembly

B

13

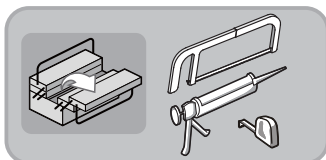
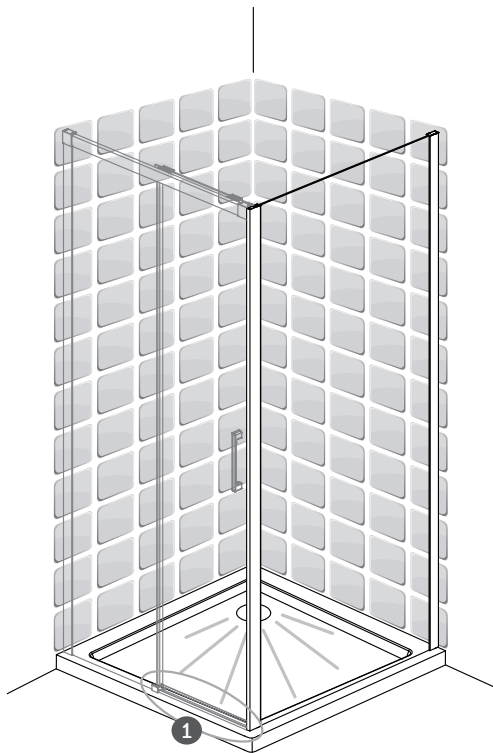
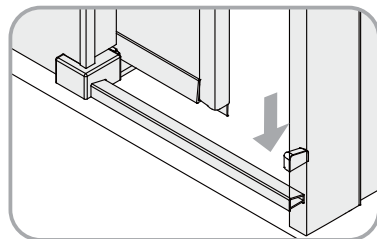
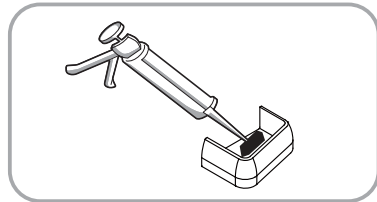
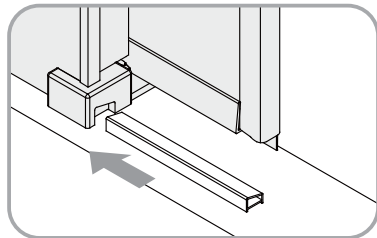
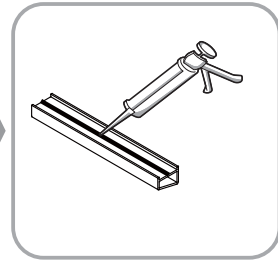
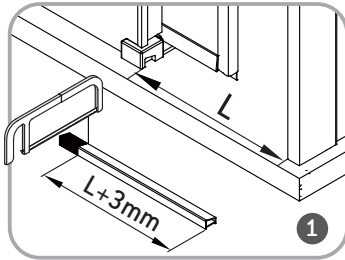

B

FR Montage

ES Montaje

PT Montagem

IT Montaggio

EL Συναρμολόγηση

PL Montaż

RU Сборка

UK Збірка

RO Montaj

EN Assembly

14

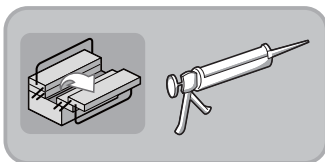
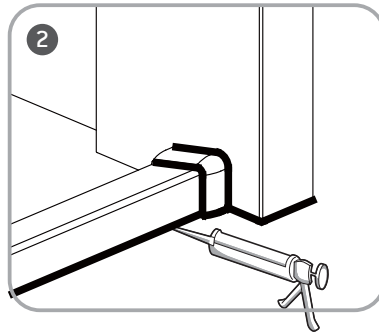
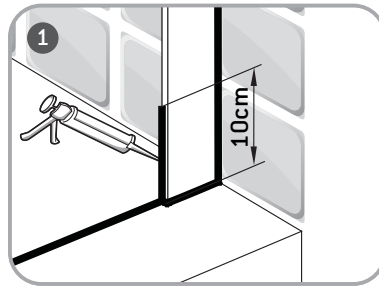
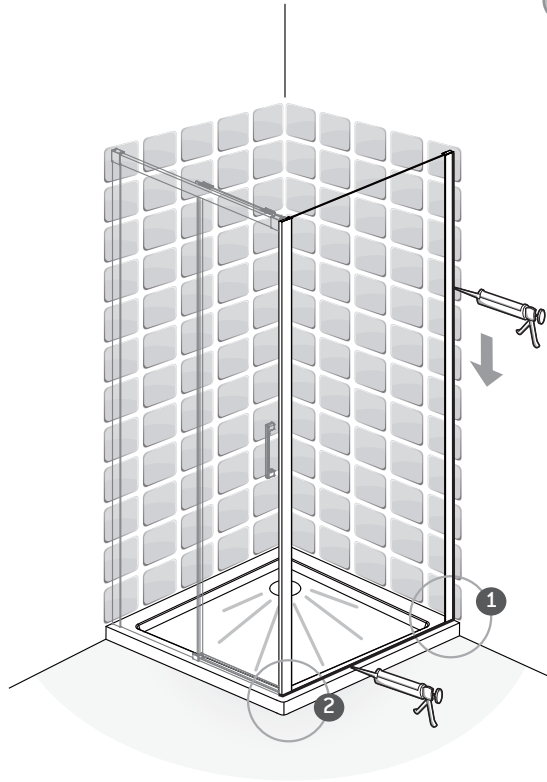
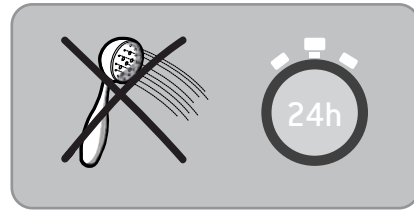

FR Montage

ES Montaje

PT Montagem

IT Montaggio

EL Συναρμολόγηση

PL Montaż

RU Сборка

UK Збірка



RO Montaj

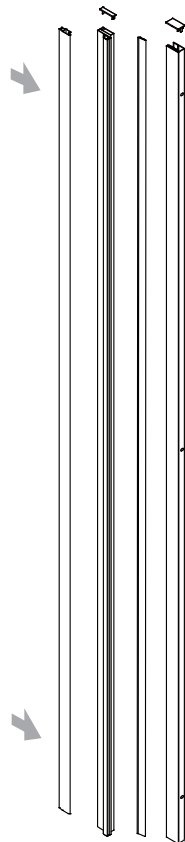
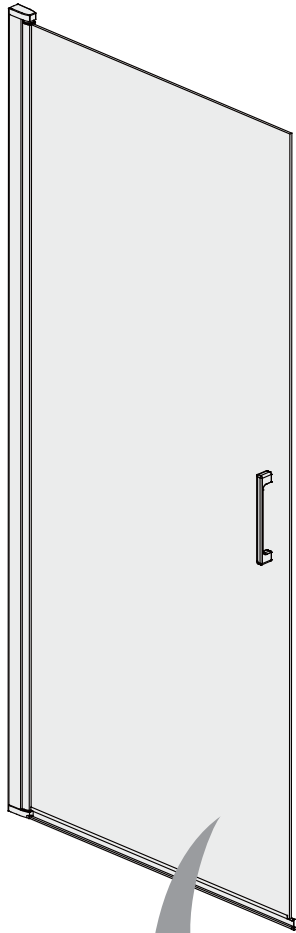

EN Assembly

B

15



H56	 x1
H58	 x2 M4x20mm
H68	 x3 ST 4x12mm

H1	 x3
H2	 x3 ST 4x40mm

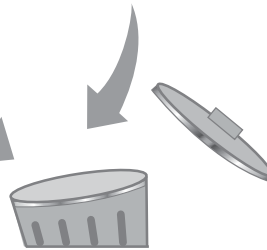

B

FR Montage

ES Montaje

PT Montagem

IT Montaggio

EL Συναρμολόγηση

PL Montaż

RU Сборка

UK Збірка

RO Montaj

EN Assembly

16

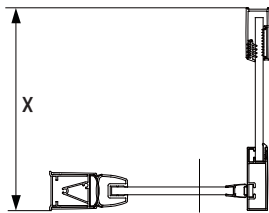

REMIX	X(mm)
700 x 1950mm	675 - 690
800 x 1950mm	775 - 790
900 x 1950mm	875 - 890
1000 x 1950mm	975 - 990

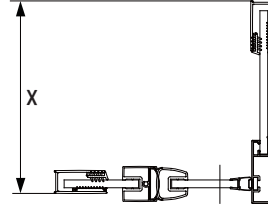

REMIX	X(mm)
700 x 1950mm	667 - 682
800 x 1950mm	767 - 782
900 x 1950mm	867 - 882
1000 x 1950mm	967 - 982

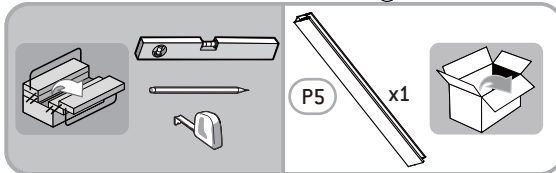
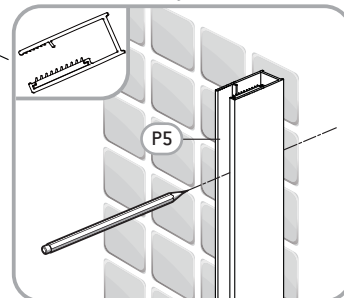
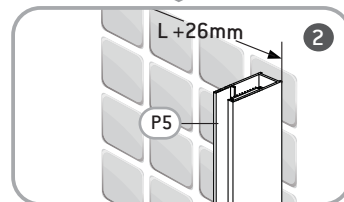
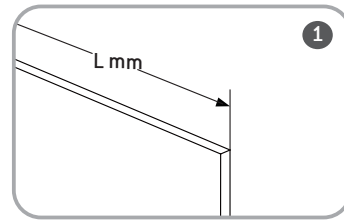
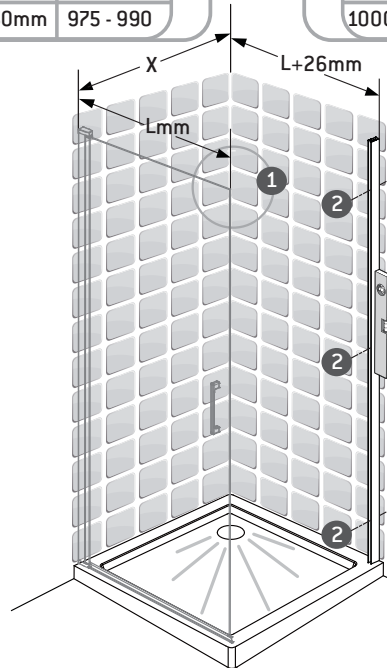

FR Montage

ES Montaje

PT Montagem

IT Montaggio

EL Συναρμολόγηση

PL Montaż

RU Сборка

UK Збірка

RO Montaj

EN Assembly

B

17

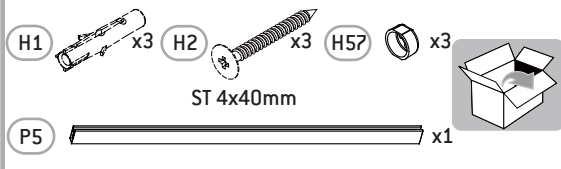
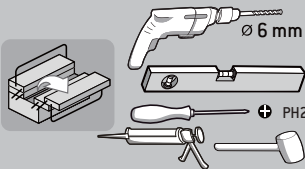
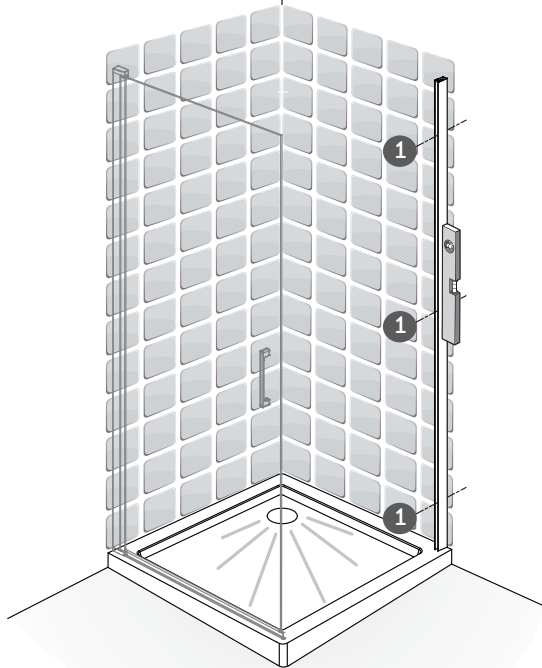
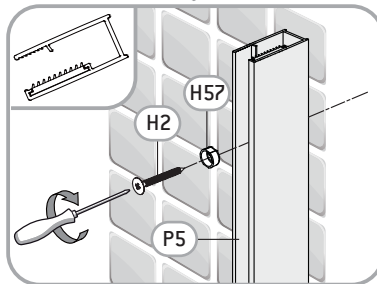
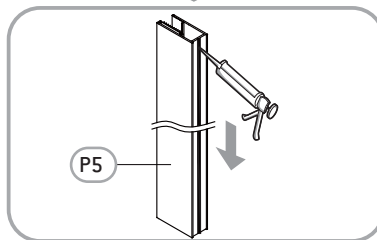
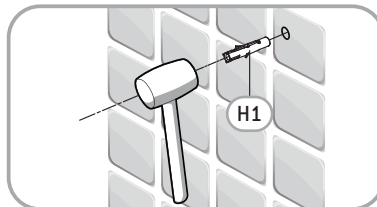
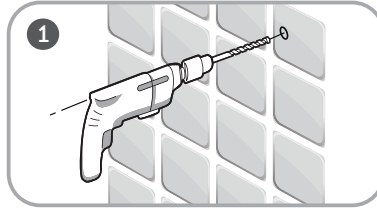
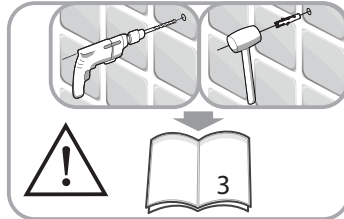

B

FR Montage

ES Montaje

PT Montagem

IT Montaggio

EL Συναρμολόγηση

PL Montaż

RU Сборка

UK Збірка

RO Montaj

EN Assembly

18

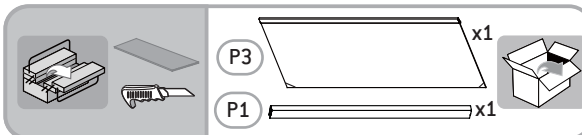
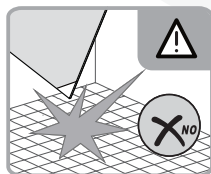
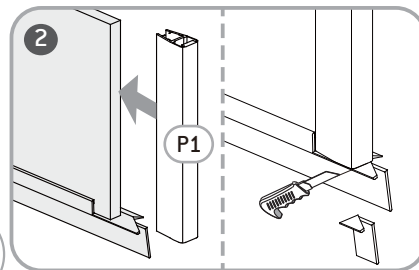
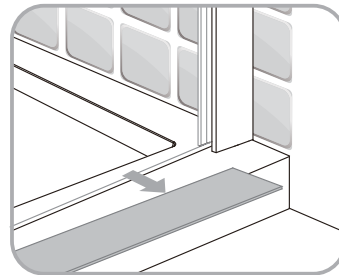
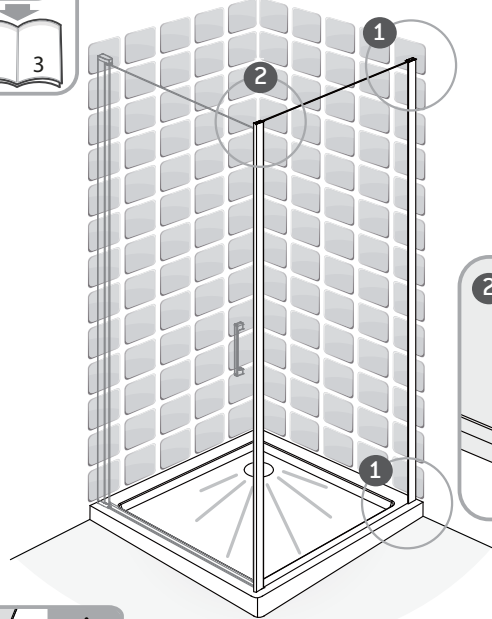
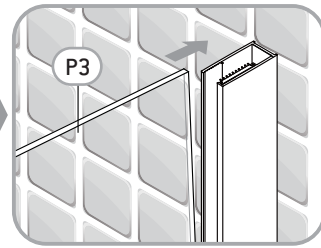
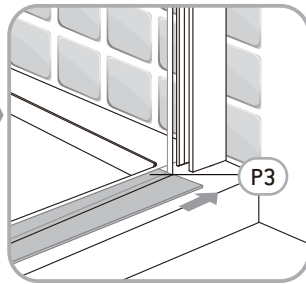
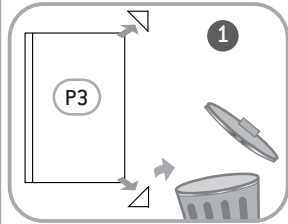

FR Montage

ES Montaje

PT Montagem

IT Montaggio

EL Συναρμολόγηση

PL Montaż

RU Сборка

UK Збірка

RO Montaj

EN Assembly

B

19

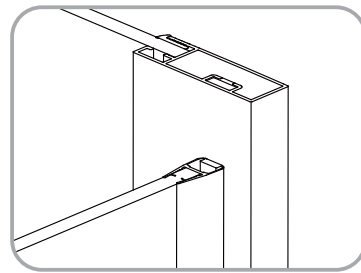
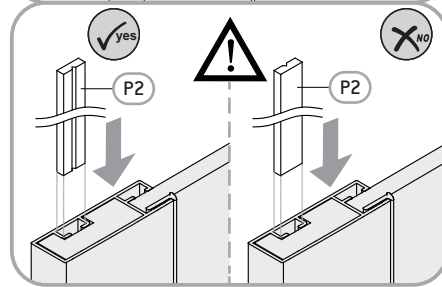
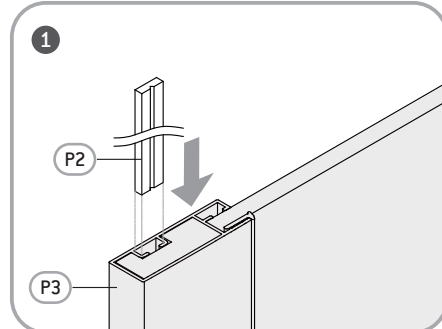
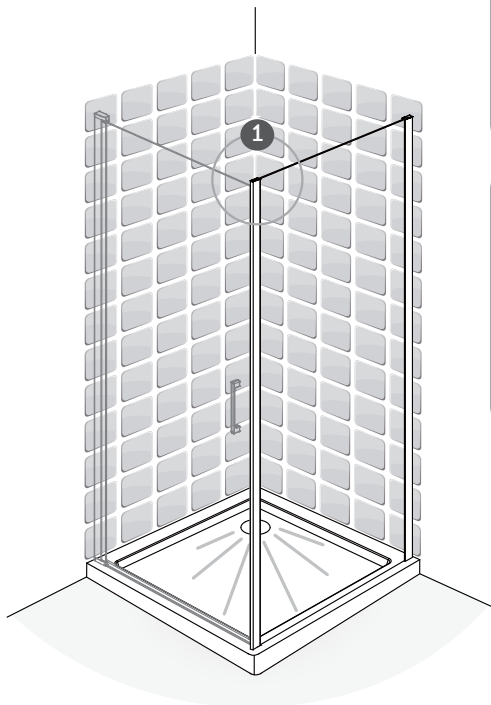

P2

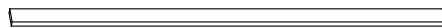

x1



B

FR Montage

ES Montaje

PT Montagem

IT Montaggio

EL Συναρμολόγηση

PL Montaż

RU Сборка

UK Збірка

RO Montaj

EN Assembly

20

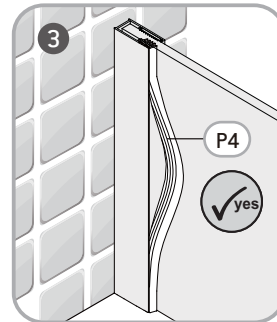
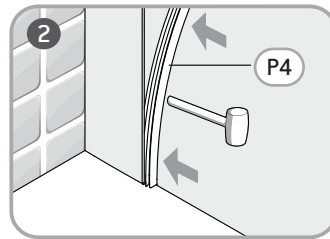
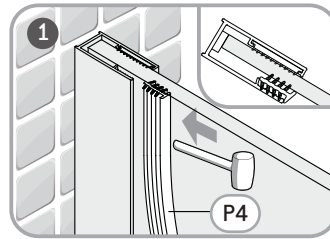
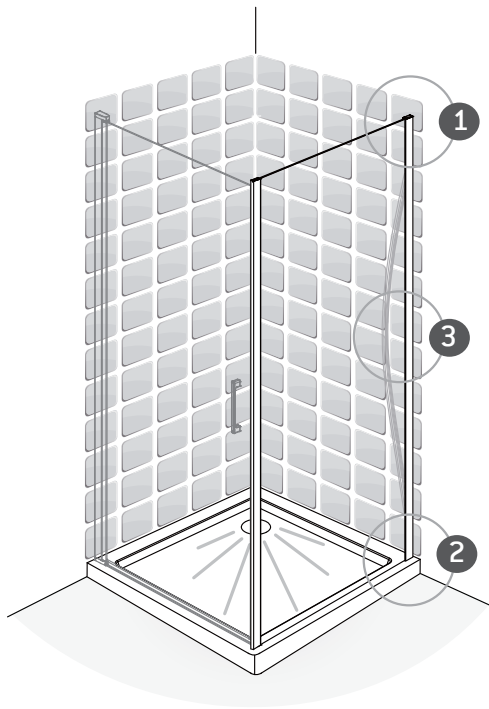

P4



x1



FR Montage

ES Montaje

PT Montagem

IT Montaggio

EL Συναρμολόγηση

PL Montaż

RU Сборка

UK Збірка

RO Montaj

EN Assembly

B

21

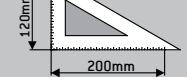
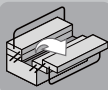
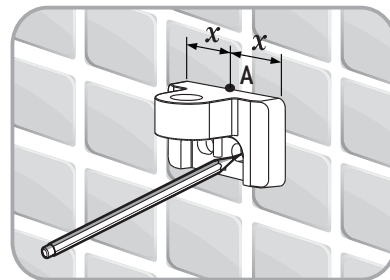
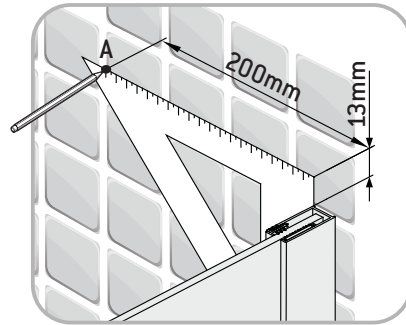
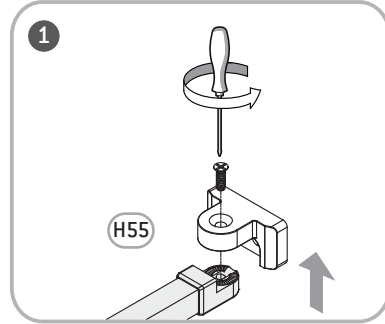
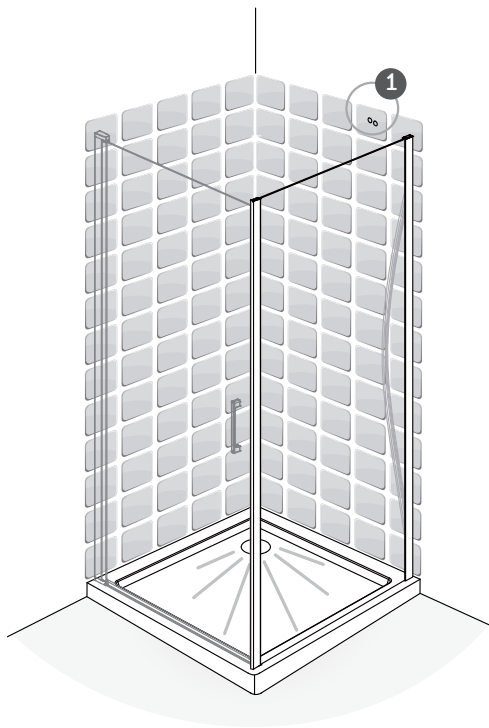

H55

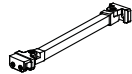

x1



B

FR Montage

ES Montaje

PT Montagem

IT Montaggio

EL Συναρμολόγηση

PL Montaż

RU Сборка

UK Збірка

RO Montaj

EN Assembly

22

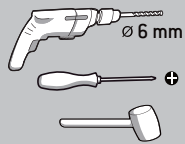
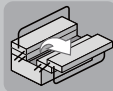
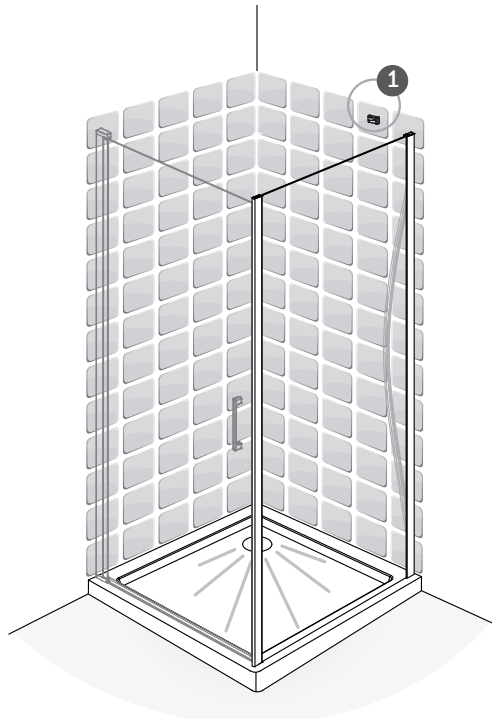
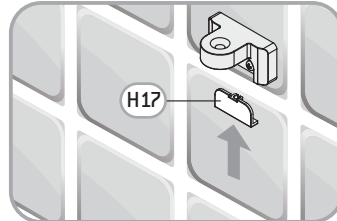
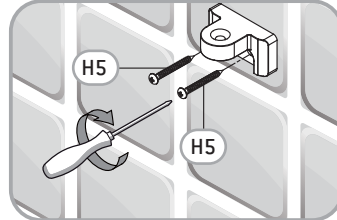
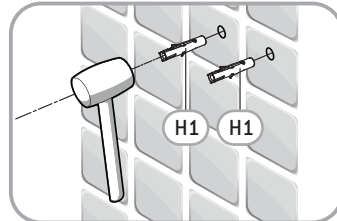
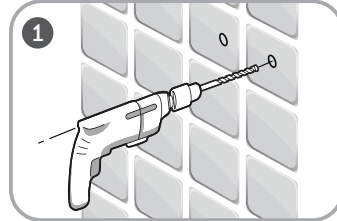
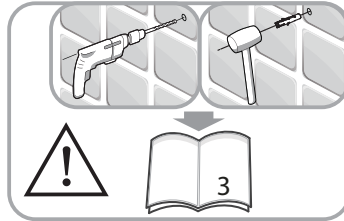

H1



x2

H17



x1

H5



x2

ST 4x30mm



x1



FR Montage

ES Montaje

PT Montagem

IT Montaggio

EL Συναρμολόγηση

PL Montaż

RU Сборка

UK Збірка

RO Montaj

EN Assembly

B

23

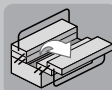
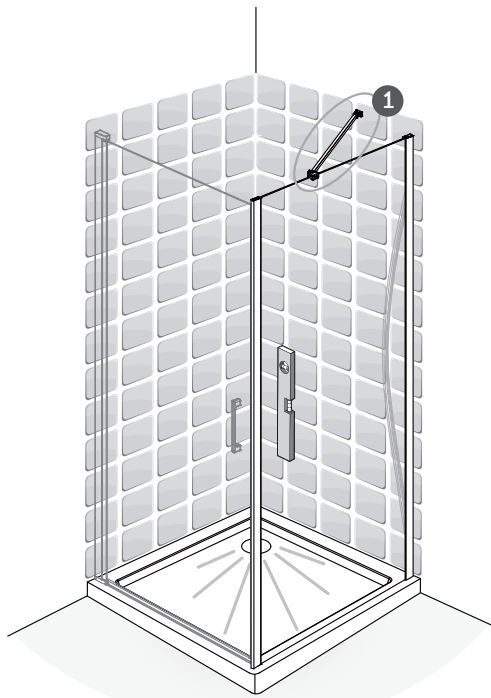
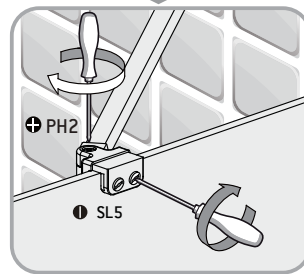
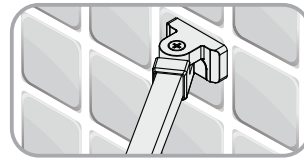
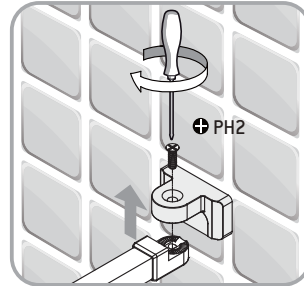
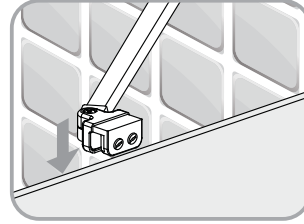
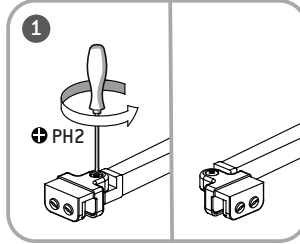

PH2



SL5



x1

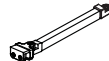

x1



B

FR Montage

ES Montaje

PT Montagem

IT Montaggio

EL Συναρμολόγηση

PL Montaż

RU Сборка

UK Збірка

RO Montaj

EN Assembly

24

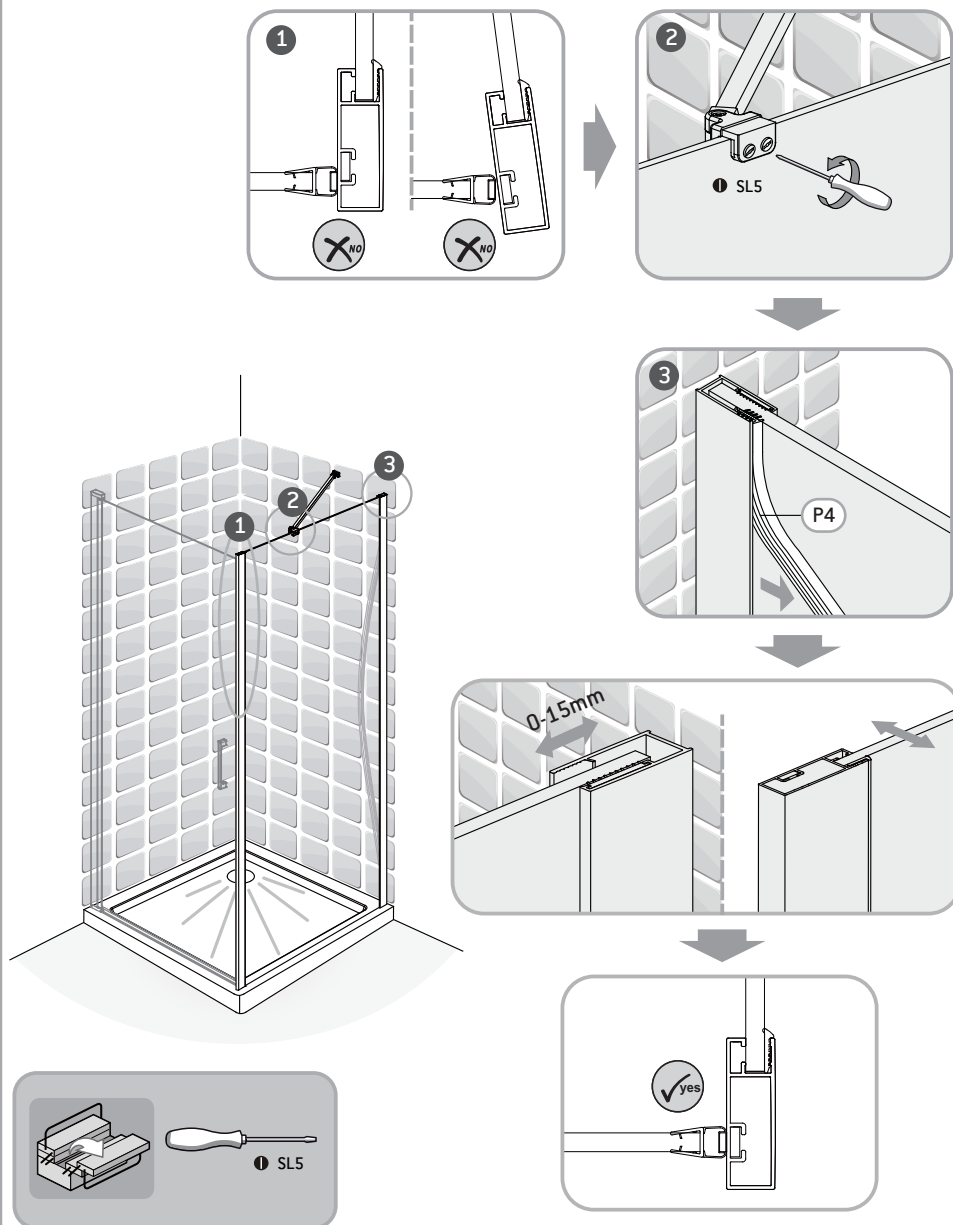

FR Montage

ES Montaje

PT Montagem

IT Montaggio

EL Συναρμολόγηση

PL Montaż

RU Сборка

UK Збірка

RO Montaj

EN Assembly

B

25

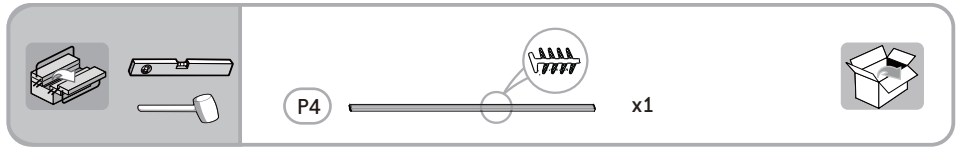
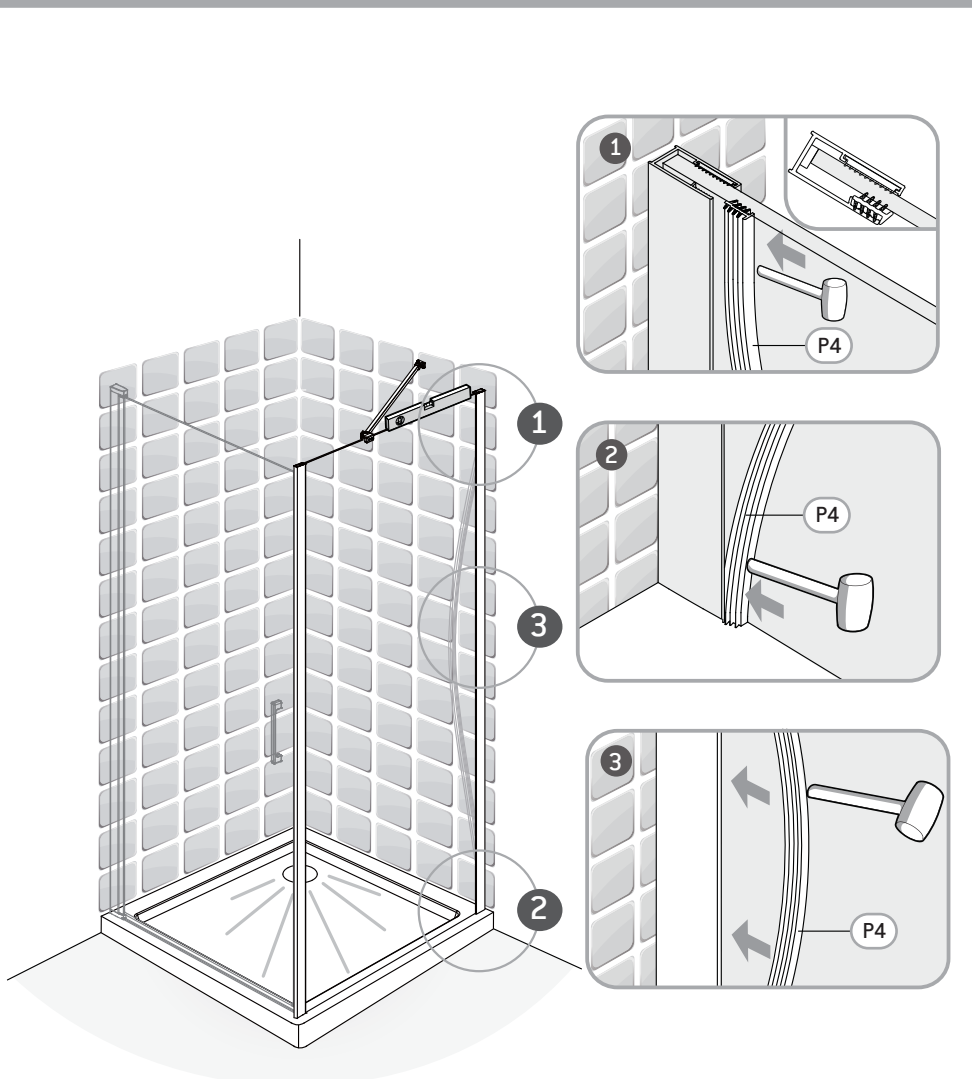

B

FR Montage

ES Montaje

PT Montagem

IT Montaggio

EL Συναρμολόγηση

PL Montaż

RU Сборка

UK Збірка

RO Montaj

EN Assembly

26

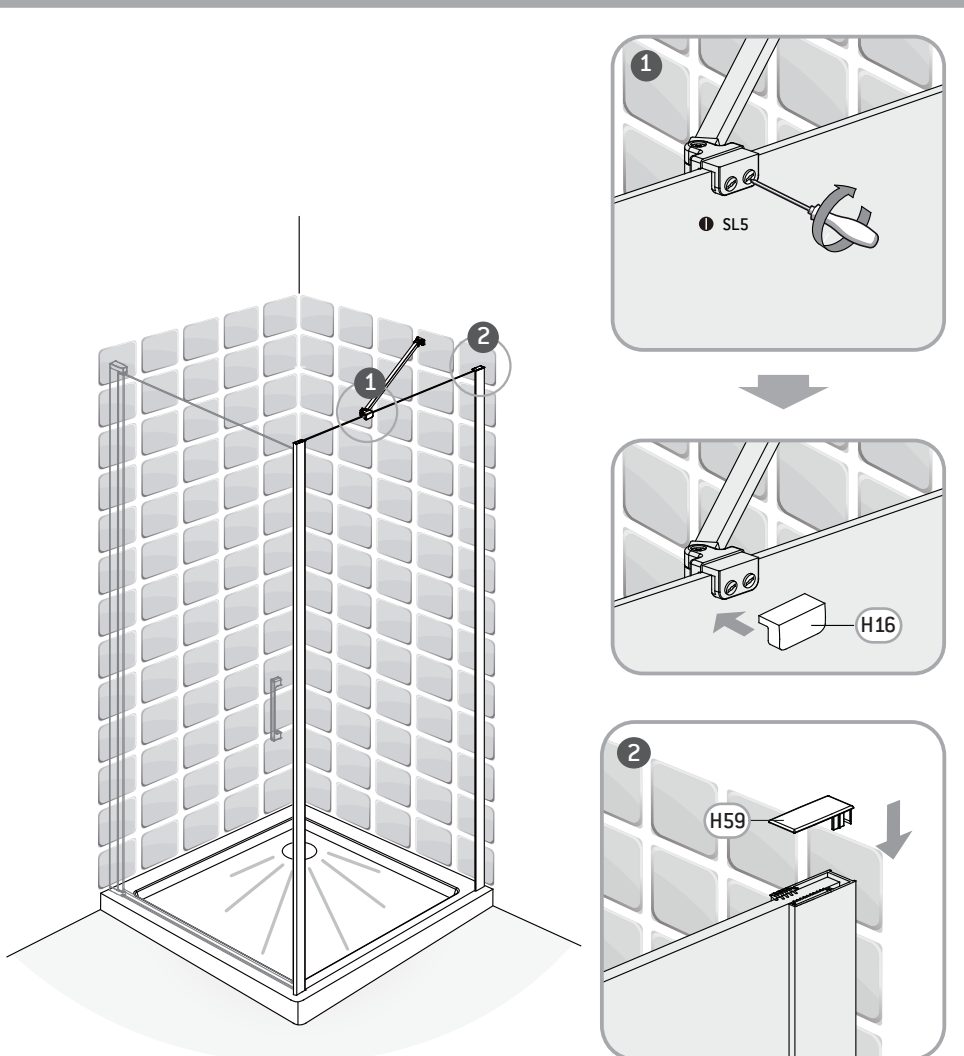

SL5

H16



x1

H59



x1



FR Montage

ES Montaje

PT Montagem

IT Montaggio

EL Συναρμολόγηση

PL Montaż

RU Сборка

UK Збірка

RO Montaj

EN Assembly

B

27

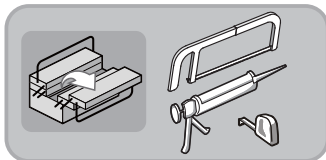
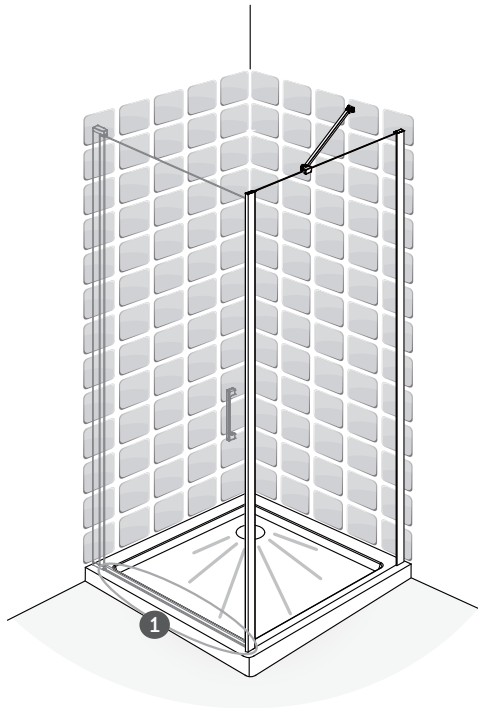
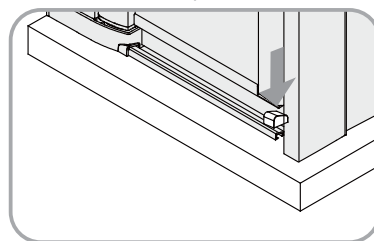
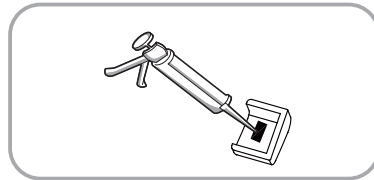
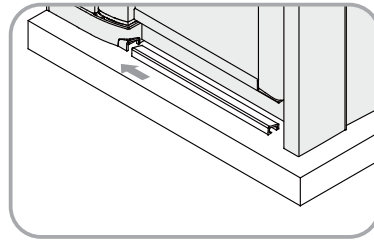
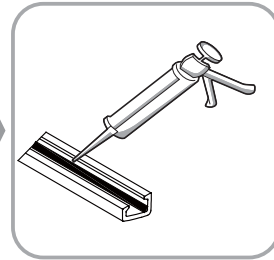
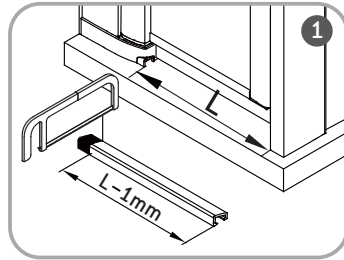

B

FR Montage

ES Montaje

PT Montagem

IT Montaggio

EL Συναρμολόγηση

PL Montaż

RU Сборка

UK Збірка

RO Montaj

EN Assembly

28

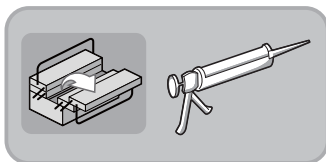
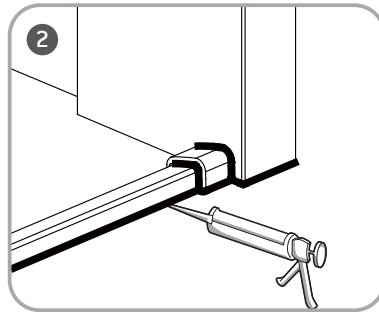
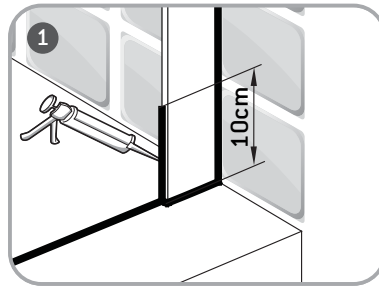
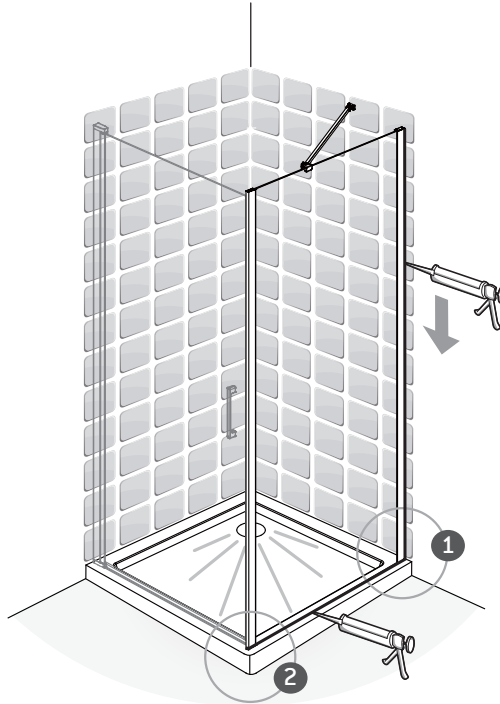
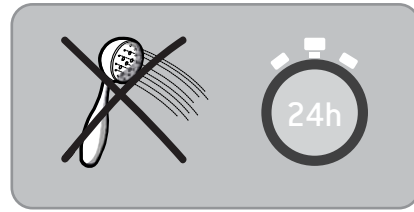

FR Montage

ES Montaje

PT Montagem

IT Montaggio

EL Συναρμολόγηση

PL Montaż

RU Сборка

UK Збірка



RO Montaj

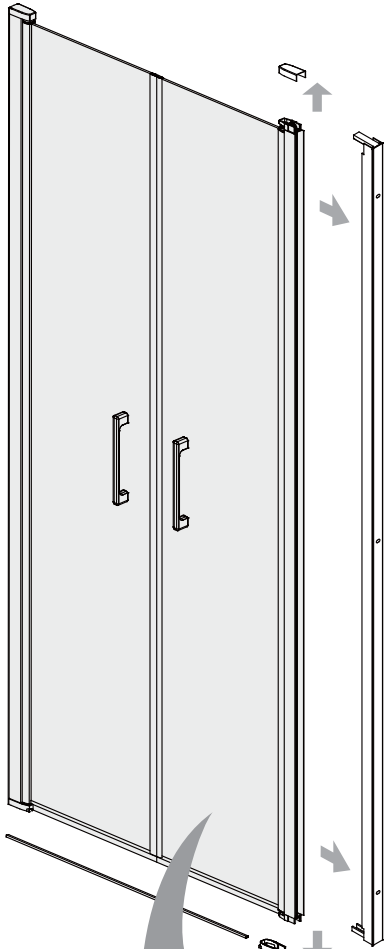

EN Assembly

B

29



H1	 x3
H2	 x3 ST 4x40mm
H24	 3mm x1

H56	 x1
H58	 x2 M4x20mm

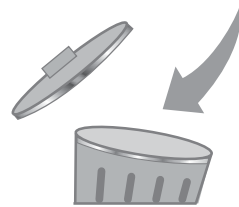

B

FR Montage

ES Montaje

PT Montagem

IT Montaggio

EL Συναρμολόγηση

PL Montaż

RU Сборка

UK Збірка

RO Montaj

EN Assembly

30

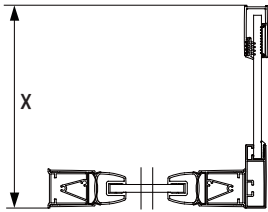

REMIX	X(mm)
700 x 1950mm	675 - 690
800 x 1950mm	775 - 790
900 x 1950mm	875 - 890
1000 x 1950mm	975 - 990

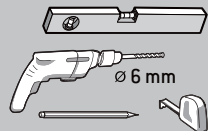
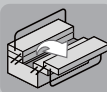
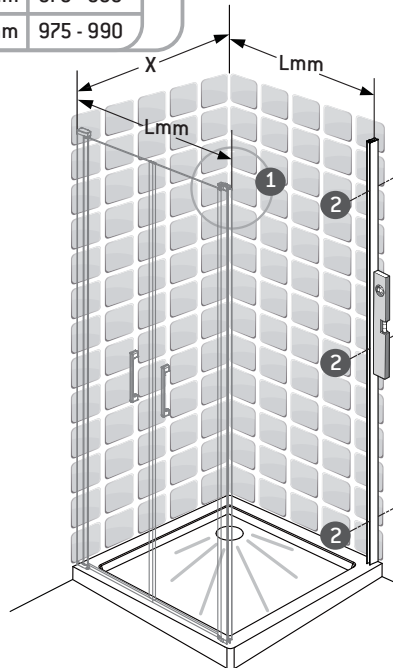
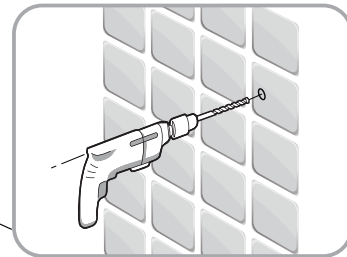
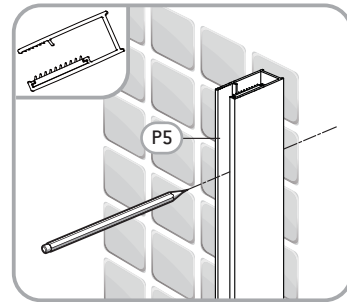
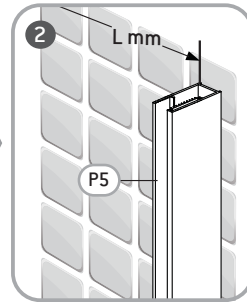
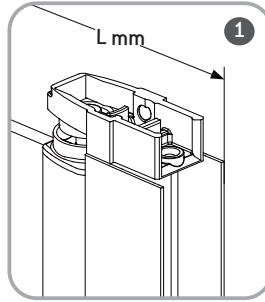

P5

x1



FR Montage

ES Montaje

PT Montagem

IT Montaggio

EL Συναρμολόγηση

PL Montaż

RU Сборка

UK Збірка

RO Montaj

EN Assembly

B

31

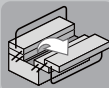
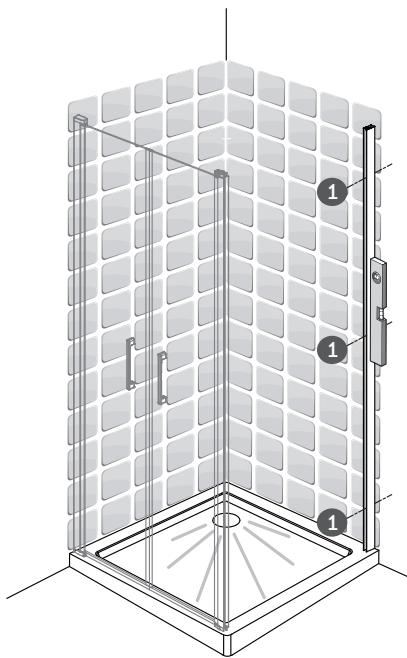
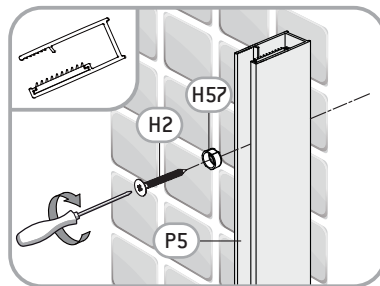
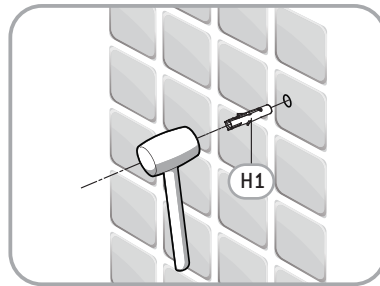
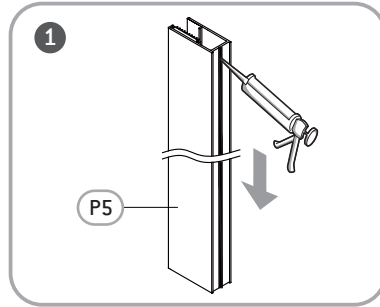
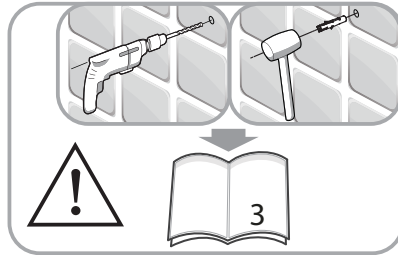

H1



x3

H2

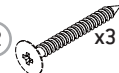

x3

H57



x3

ST 4x40mm

P5



x1



B

FR Montage

ES Montaje

PT Montagem

IT Montaggio

EL Συναρμολόγηση

PL Montaż

RU Сборка

UK Збірка

RO Montaj

EN Assembly

32

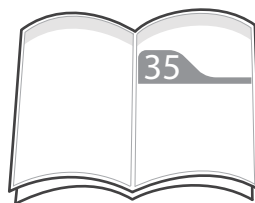
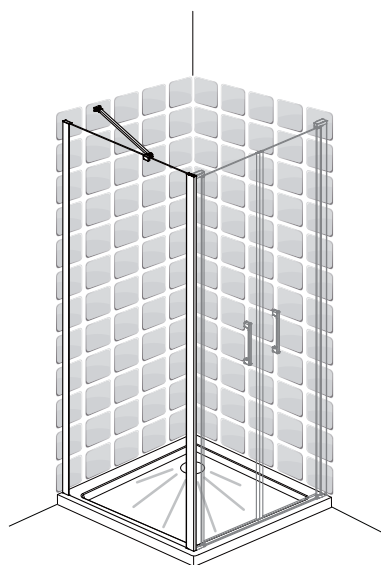
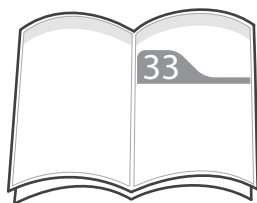
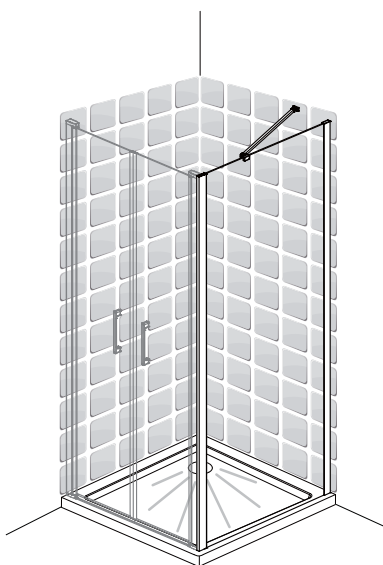

FR Montage

ES Montaje

PT Montagem

IT Montaggio

EL Συναρμολόγηση

PL Montaż

RU Сборка

UK Збірка

RO Montaj

EN Assembly

B

33

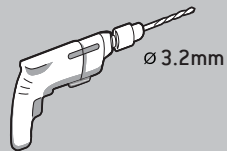
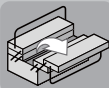
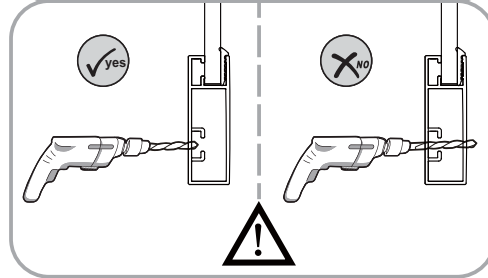
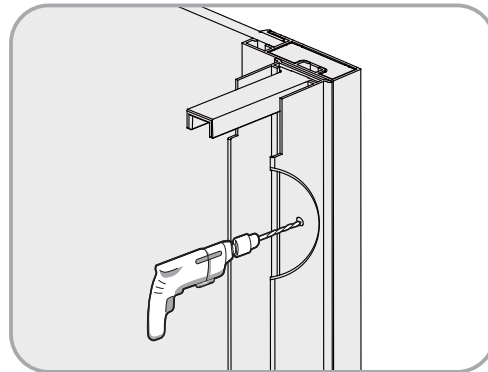
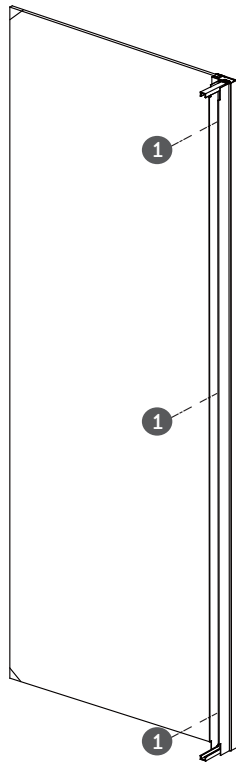
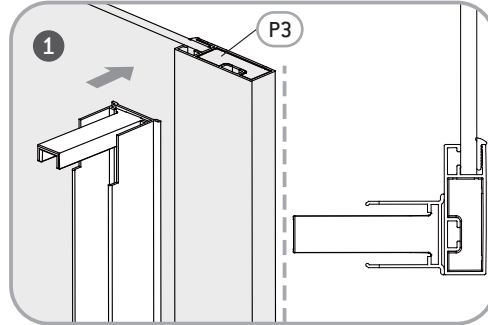
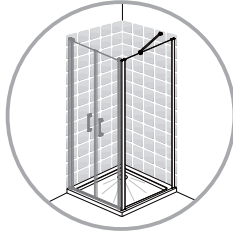

Ø 3.2mm

P3



x1

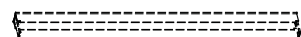

x1



B

FR Montage

ES Montaje

PT Montagem

IT Montaggio

EL Συναρμολόγηση

PL Montaż

RU Сборка

UK Збірка

RO Montaj

EN Assembly

34

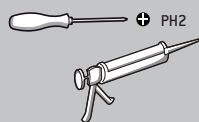
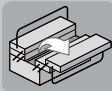
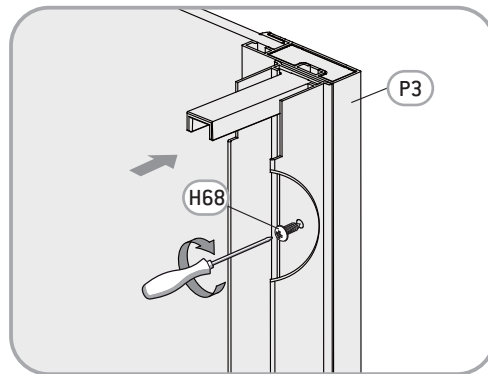
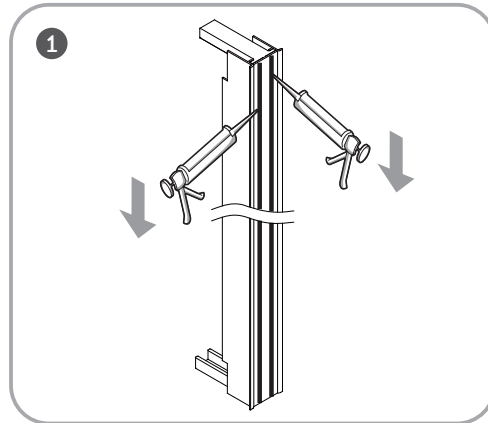
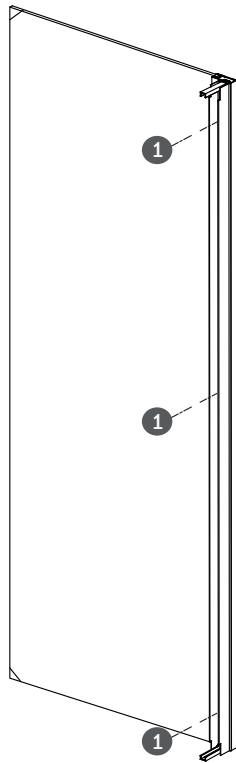
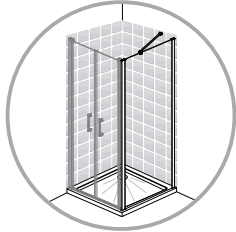

P3

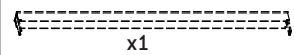

H68 x3
ST 4x12mm



FR Montage

ES Montaje

PT Montagem

IT Montaggio

EL Συναρμολόγηση

PL Montaż

RU Сборка

UK Збірка

RO Montaj

EN Assembly

B

35

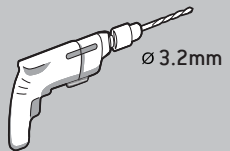
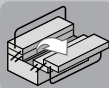
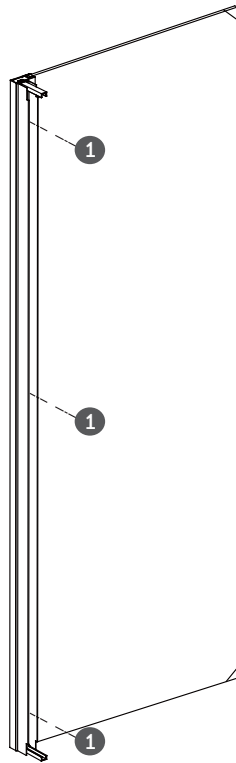
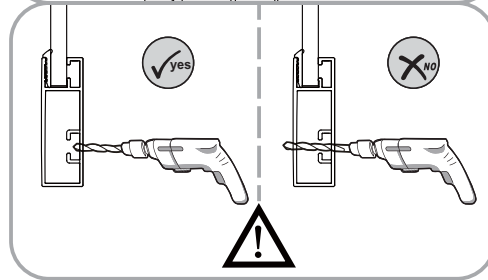
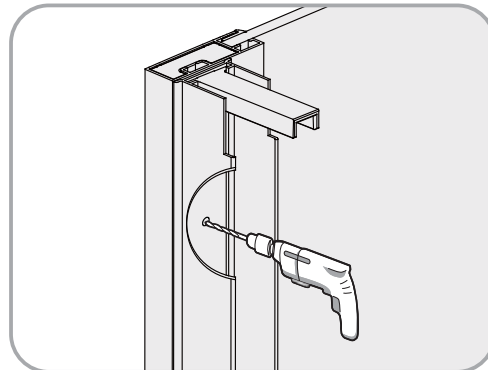
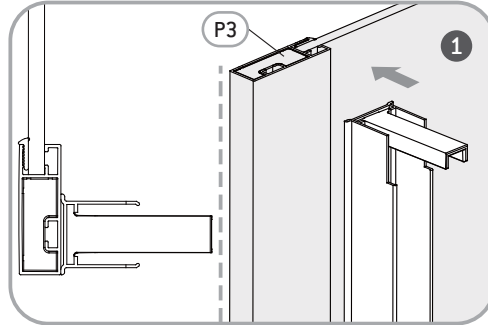
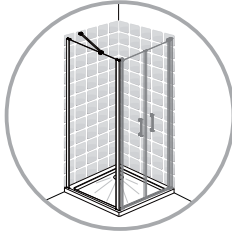

P3



x1

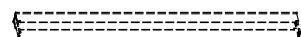

x1



B

FR Montage

ES Montaje

PT Montagem

IT Montaggio

EL Συναρμολόγηση

PL Montaż

RU Сборка

UK Збірка

RO Montaj

EN Assembly

36

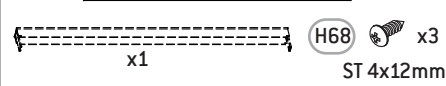
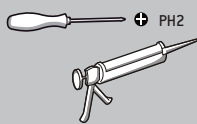
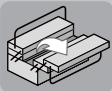
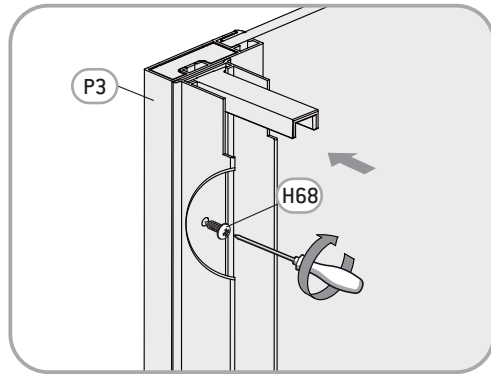
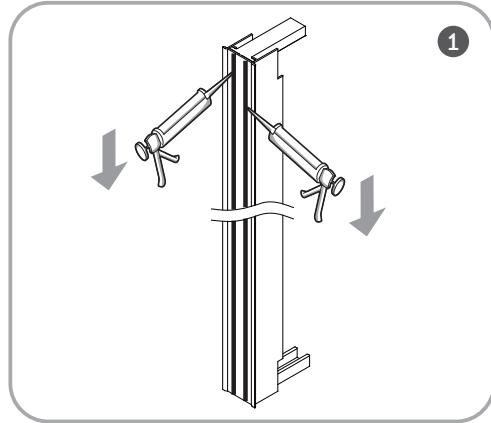
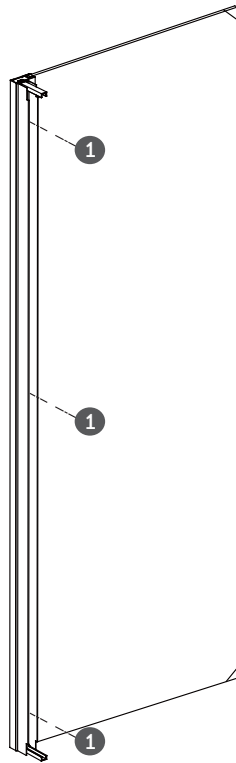
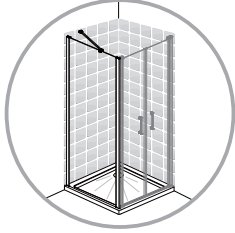

FR Montage

ES Montaje

PT Montagem

IT Montaggio

EL Συναρμολόγηση

PL Montaż

RU Сборка

UK Збірка

RO Montaj

EN Assembly

B

37

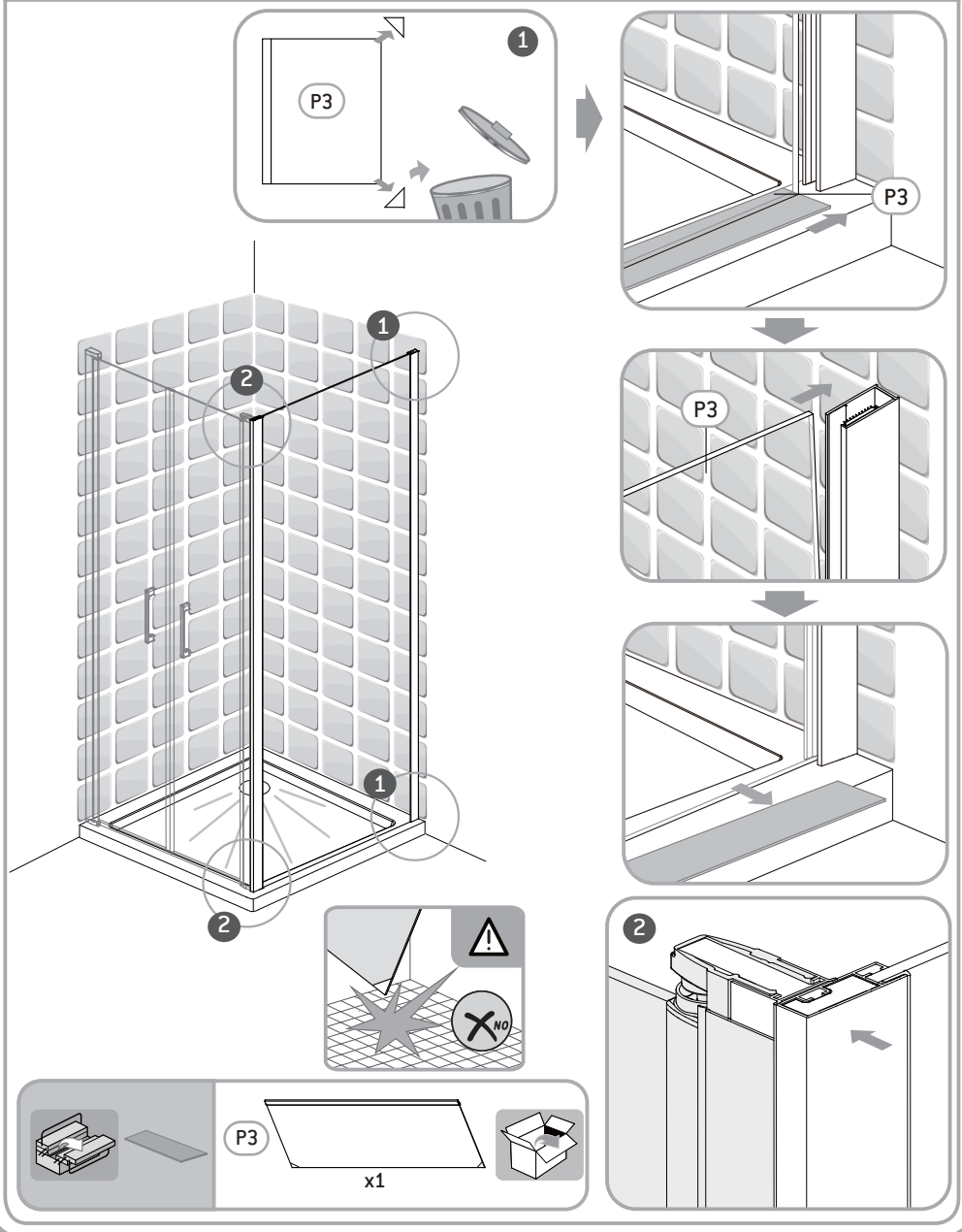

B

- FR Montage
- ES Montaje
- PT Montagem
- IT Montaggio
- EL Συναρμολόγηση
- PL Montaż
- RU Сборка
- UK Збірка
- RO Montaj
- EN Assembly

38

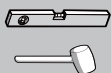
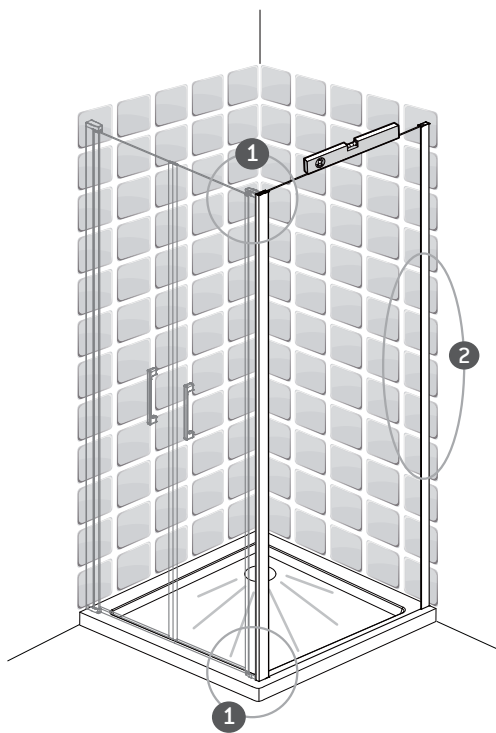
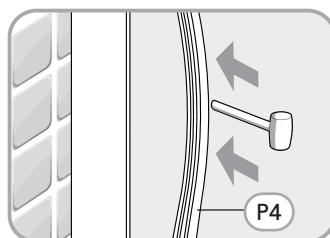
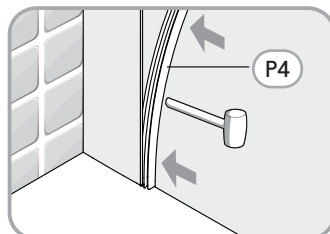
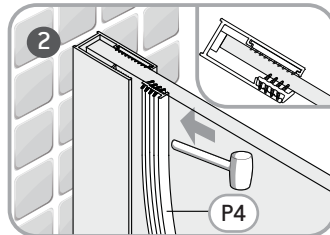
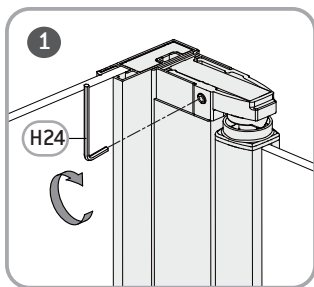

P4

x1

H24

3mm



FR Montage

ES Montaje

PT Montagem

IT Montaggio

EL Συναρμολόγηση

PL Montaż

RU Сборка

UK Збірка

RO Montaj

EN Assembly

B

39

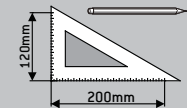
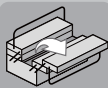
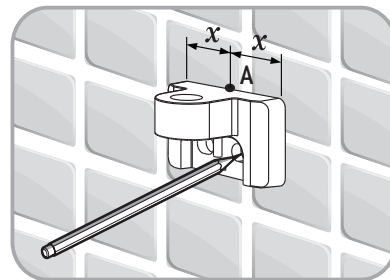
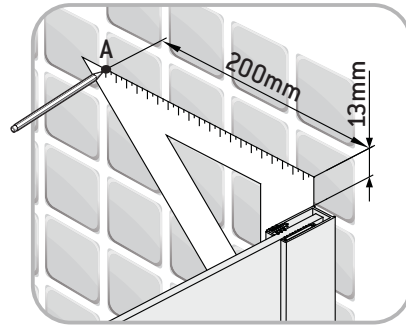
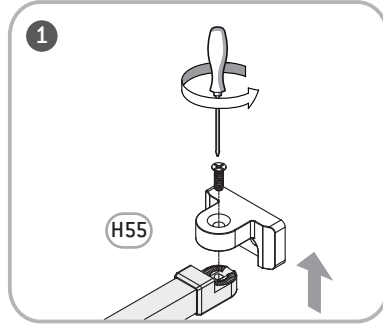
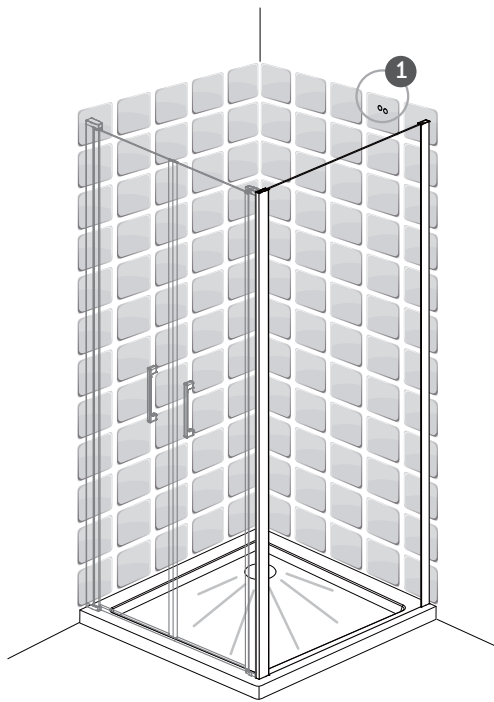

H55

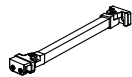

x1



B

FR Montage

ES Montaje

PT Montagem

IT Montaggio

EL Συναρμολόγηση

PL Montaż

RU Сборка

UK Збірка

RO Montaj

EN Assembly

40

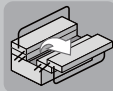
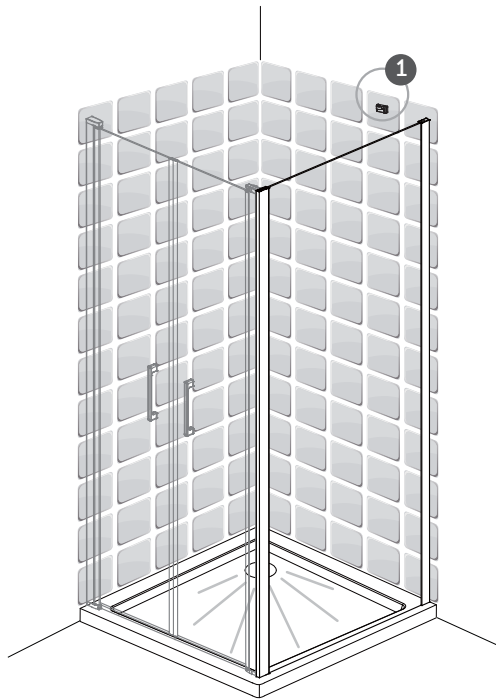
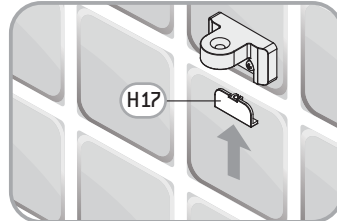
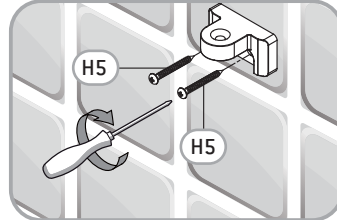
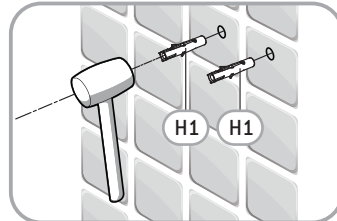
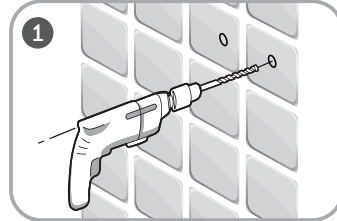
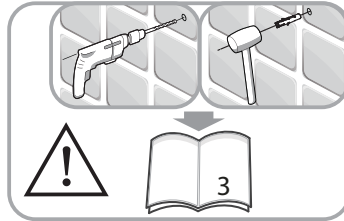

H1



x2

H17



x1

H5



x2

ST 4x30mm



x1



FR Montage

ES Montaje

PT Montagem

IT Montaggio

EL Συναρμολόγηση

PL Montaż

RU Сборка

UK Збірка

RO Montaj

EN Assembly

B

41

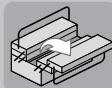
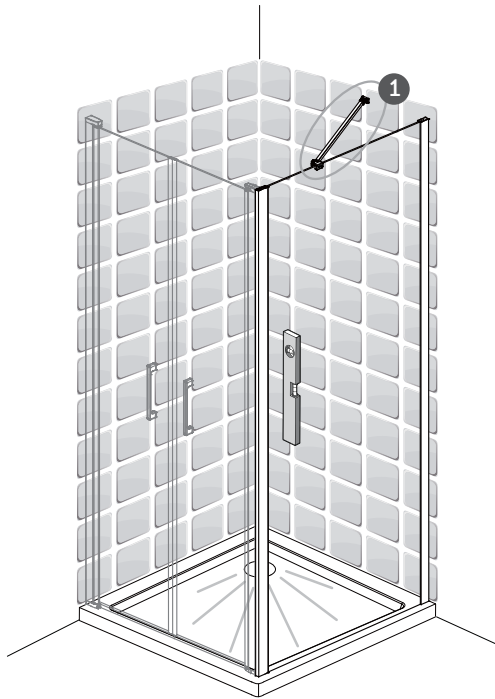
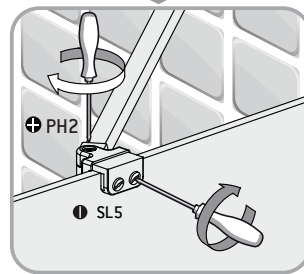
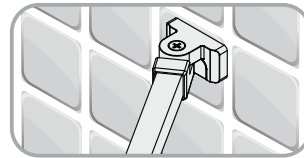
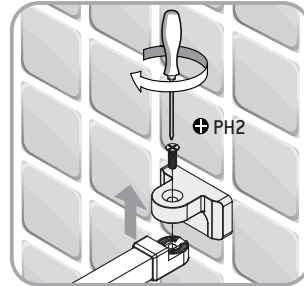
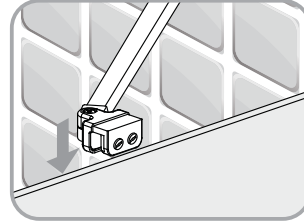
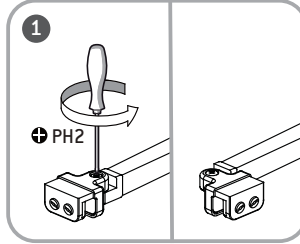

PH2



SL5



x1

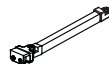

x1



B

FR Montage

ES Montaje

PT Montagem

IT Montaggio

EL Συναρμολόγηση

PL Montaż

RU Сборка

UK Збірка

RO Montaj

EN Assembly

42

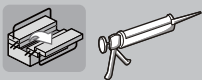
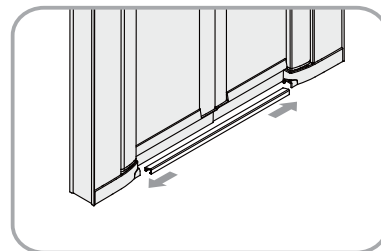
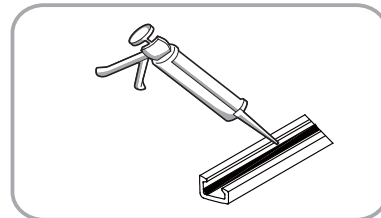
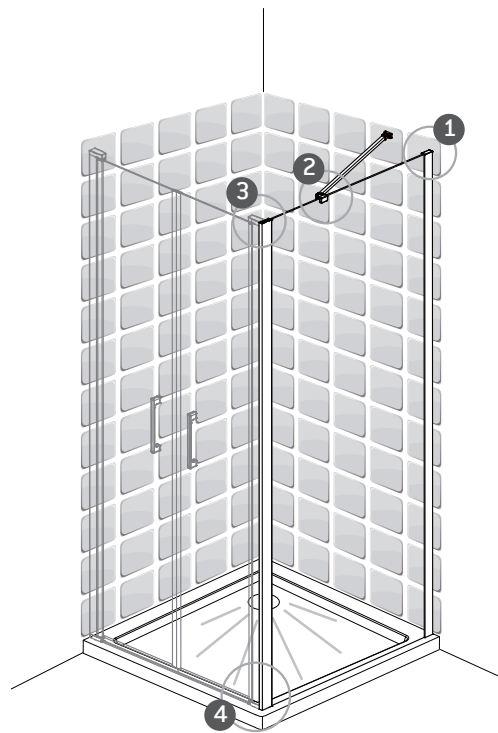
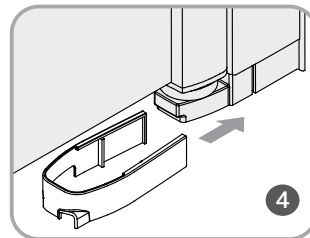
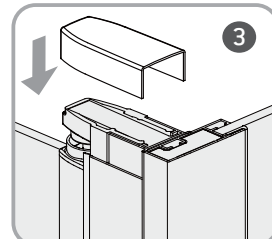
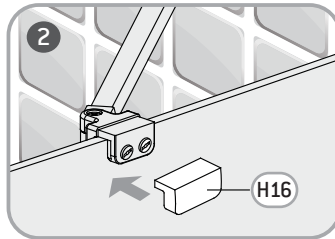
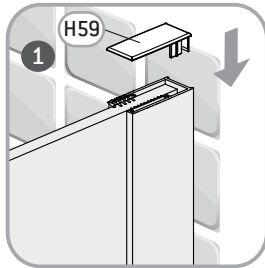

H16



x1

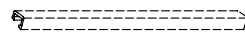

x1

H59



x1



x1



x1



FR Montage

ES Montaje

PT Montagem

IT Montaggio

EL Συναρμολόγηση

PL Montaż

RU Сборка

UK Збірка

RO Montaj

EN Assembly

B

43

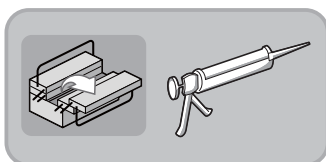
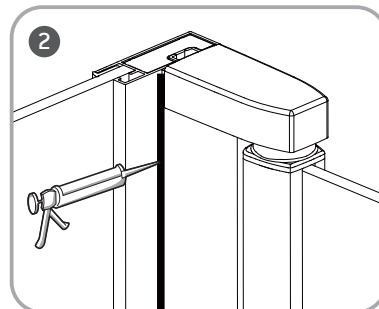
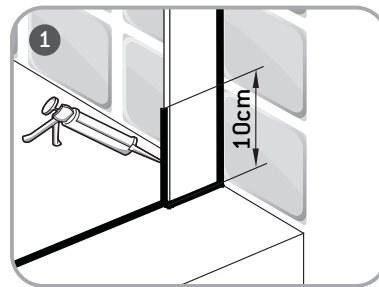
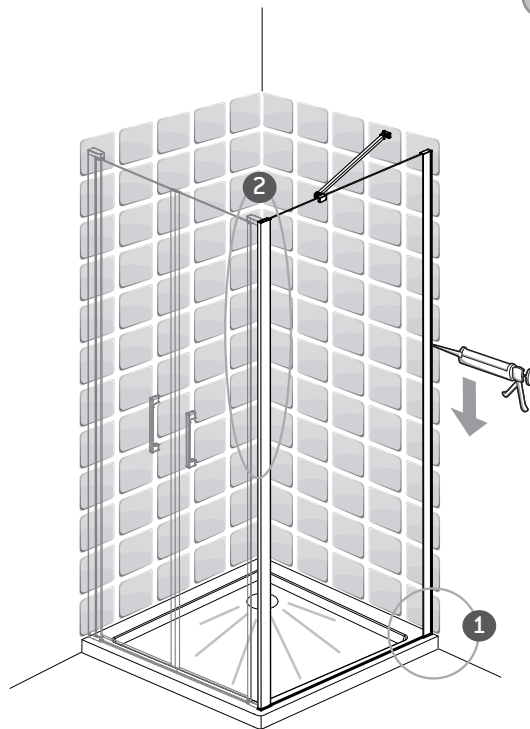
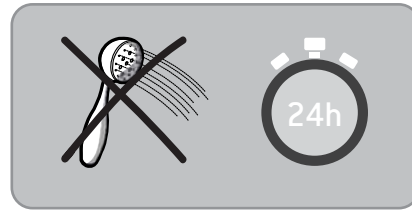

C

FR Entretien

ES Mantenimiento

PT Serviço

IT Manutenzione

EL Συντήρηση

PL Konserwacja

RU Уход

UK Догляд

RO Întreținere

EN Maintenance



Sans solvant / Sin disolvente / Sem solventes / Senza solventi / Χωρίς διαλυτικά / Bez rozpuszczalnika / Без растворителя / Без розчинника / Fără solvent / Solvent-free

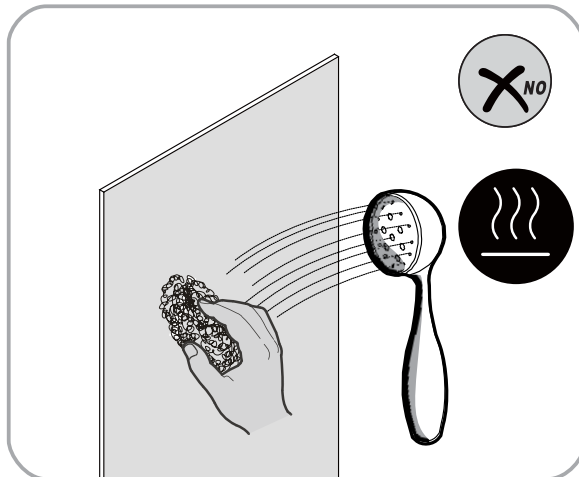
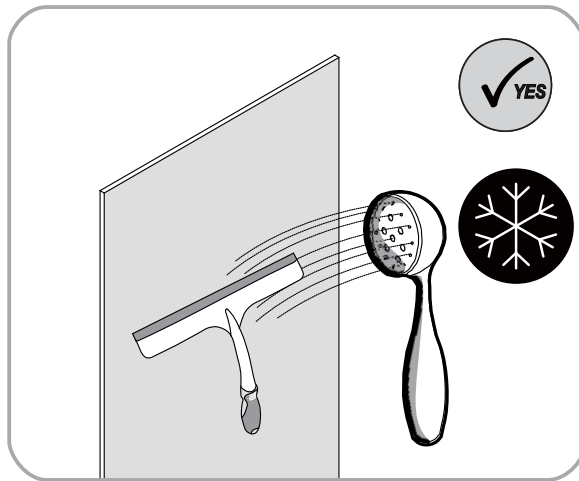

FR

CE

ADEO Services -135 Rue Sadi Carnot -
CS 00001 59790 RONCHIN - France
16
EN 14428:2015

Code d'identification unique
du produit type: **

usage prévu: hygiène personnelle

Nettoyable: Conforme

Résistance à l'impact/
Capacité de Fragmentation: Conforme

durabilité: Conforme

DOP N ° 204003/0001/2016

ES

CE

ADEO Services -135 Rue Sadi Carnot -
CS 00001 59790 RONCHIN - France
16
EN 14428:2015

Código de identificación
única del producto tipo: **

Usó previsto: higiene personal

Limpiable: Conforme

Resistencia al impacto/
Capacidad de fragmentación: Conforme

Durabilidad: Conforme

DOP N ° 204003/0001/2016

PT

CE

ADEO Services -135 Rue Sadi Carnot -
CS 00001 59790 RONCHIN - France
16
EN 14428:2015

Código de identificação
único do produto-tipo: **

Utilização prevista: higiene pessoal

Limpeza: Conforme

Resistência ao impacto/
Capacidade de fragmentação: Conforme

Durabilidade: Conforme

DOP N ° 204003/0001/2016

IT

CE

ADEO Services -135 Rue Sadi Carnot -
CS 00001 59790 RONCHIN - France
16
EN 14428:2015

Codice di identificazione
unico del prodotto-tipo: **

Usó previsto: igiene personale

Pulibile: Conforme

Resistenza agli urti/
Capacità di Frammentazione: Conforme

Durata: Conforme

DOP N ° 204003/0001/2016

EL

CE

ADEO Services -135 Rue Sadi Carnot -
CS 00001 59790 RONCHIN - France
16
EN 14428:2015

Μοναδικός κωδικός ταυτοποίησης
του τύπου του προϊόντος: **

προβλεπόμενη χρήση: προσωπική υγιεινή

Δυνατότητα καθαρισμού: Σύμφωνα με

Αντοχή σε κρούση/
Ικανότητα κατάτμησης: Σύμφωνα με

Διάρκεια: Σύμφωνα με

DOP N ° 204003/0001/2016

PL

CE

ADEO Services -135 Rue Sadi Carnot -
CS 00001 59790 RONCHIN - France
16
EN 14428:2015

Niepowtarzalny kod
identyfikacyjny typu wyrobu: **

przeznaczenie: higiena osobista

Możliwość czyszczenia: Zgodny

Odporność na uderzenia/
Rozkruszalność: Zgodny

Trwałość: Zgodny

DOP N ° 204003/0001/2016

RU

CE

ADEO Services -135 Rue Sadi Carnot -
CS 00001 59790 RONCHIN - France
16
EN 14428:2015

Уникальный идентификационный
код типа изделия: **

Назначение: личная гигиена

Легкость очистки: Соответствие

Ударопрочность/
Мощность распыления: Соответствие

Долговечность: Соответствие

DOP N ° 204003/0001/2016

UK

CE

ADEO Services -135 Rue Sadi Carnot -
CS 00001 59790 RONCHIN - France
16
EN 14428:2015

Унікальний ідентифікаційний
код виду продукції: **

призначення: особиста гігієна

Легкість очищення: Відповідність

Ударостійкість/
Потужність розпилення: Відповідність

Довговічність: Відповідність

DOP N ° 204003/0001/2016

RO

CE

ADEO Services -135 Rue Sadi Carnot -
CS 00001 59790 RONCHIN - France
16
EN 14428:2015

Cod unic de identificare
a tipului de produs: **

destinație: igienă personală

Posibilitatea de curățare: Conform

Rezistență la impact/
Capacitate de fragmentare: Conform

Durabilitate: Conform

DOP N ° 204003/0001/2016

EN

CE

ADEO Services -135 Rue Sadi Carnot -
CS 00001 59790 RONCHIN - France
16
EN 14428:2015

Unique identification code
of the product-type: **

Intended use: personal hygiene

cleanability: Pass

Impact resistance/ shatter properties: Pass

Durability: Pass

DOP N ° 204003/0001/2016

- **
- FR** Reportez-vous à l'annexe.
- ES** Consulte el apéndice.
- PT** Consulte o anexo.
- IT** Consultare l'appendice.
- EL** Ανατρέξτε στο Παράρτημα.
- PL** Patrz załącznik.
- RU** См. приложение.
- UK** Читайте додаток.
- RO** Consultați anexa.
- EN** Refer to appendix.

* Garantie 3 ans / Garantía 3 años / Garantia 3 anos / Garanzia 3 anni
Εγγύηση 3 ετών / Gwarancja 3 lat / 3 летняя / 3-річна гарантія
3 ani garanție / Guarantee 3 years

ADEO Services
135 Rue Sadi Carnot
CS 00001
59790 RONCHIN - France

ТОВ «Леруа Мерлен Україна»,
вул. Полярна 17а, м. Київ
04201, Україна

ООО ЛЕРУА МЕРЛЕН ВОСТОК,
141031, Московская область,
Мытищинский район, г. Мытищи,
Осташковское шоссе, д.1, РОССИЯ

Made In P. R.C. 2016